

HAEBERLE

mobile workstations

Type list valid from 1 July 2019

sturdy and robust

equipment cart systems



SWINGO[®]

swingo

SWINGO® 45 and 60

The sturdy equipment cart system in wood-plastic version

The basis of the **swingo®** cart system is a super-stable aluminium carrier profile. It offers many mounting options for various system parts and accessories. An integrated cable duct ensures comfortable cable management. Rods with Ø 25 mm can be safely inserted into the profile from the top, thus saving space. Trays and drawers can easily be fixed in predetermined steps in the frame.

- **Chassis:** Made of tubular steel, fine structure matt, grey (RAL 7012), powder-coated.
- **Castors:** Smoothly-running castors Ø 100 mm or Ø 125 mm by standard. Optionally available with brakes or electrically conductive castors.

- **Trays:** Wood-plastic combination, high-quality laminated, with all round 22 mm thick edging, non-fade and without formaldehyde.

- **Drawers:** Wood-plastic combination, high-quality laminated, non-fade and without formaldehyde, easy-glide ball bearing telescopic guide with engaging mechanism, closed, easy-to-clean surfaces.

- **Colours:** Handles and decorative strips in 3 modern colours according to the NCS design scale: grey, blue, yellow. Drawer handles are also available in red violet, turquoise, white and black.

- **Load capacity:**

Drawer surface load up to 10 kg, tray surface load up to 30 kg. Maximum overall load taking into account the aspect of tilt safety, up to 120 kg.

- **Dim.:**

Width swingo® 60: 700 mm
swingo® 45: 545 mm
Depth swingo® 60: 560 mm
swingo® 45: 560 mm

- **Heights:** different, depending on the models. Special heights on request. Measurements in 52 mm step.

A quality product made in Stuttgart. Patented design and registered pattern.

SWINGO®-clinic 45 and 60

The robust equipment cart system in metal version

swingo®-clinic is the series in metal design for clinical use. Visually the system is adapted to the swingo®-line and offers countless further advantages:

- **Sturdy, non-twisting metal construction** with a load capacity up to 130 kg for castors with Ø 100 mm or 125 mm, up to 250 kg for castors with Ø 150 mm.
- **Trays and drawers** are made of quality plated steel sheet, they are resistant against disinfectants, easy to clean and non-fade. Colour: grey-white (RAL 9002). All trays are 22 mm thick, very stable and fixed twice at two

sides in order to prevent unwanted inclination of the trays caused by high loading. Tray surface load up to 50 kg.

- **The super-stable aluminium carrier profile** offers unknown possibilities to fix system parts and various accessories.

- **The integrated cable duct** offers comfortable cable management.

- **Drawers** with telescopic full-pull-out and modern guidance ensure high handling comfort. Drawer surface load up to 10 kg.

- **Castors** high quality in different sizes (Ø 100, 125 or 150 mm) guarantee the manoeuvrability of the cart even highly loaded.

- **Colours:** Push handles and decorative strips in 3 modern accent colours grey, blue, yellow are available according to the NCS colour scale. Drawer handles are additionally available in red violet, turquoise, white and black.

Please order the practical and stylish push handles separately.



POAG equipotential bonding system conforming to DIN 42801

In rooms used for medical purposes, equipment and other conductive parts may have different potentials, which poses a risk to persons. Equipotential bonding offers safe protection.

Therefore, a POAG pin will be mounted on selected equipment carts at the factory, and undergo electrical testing as part of final acceptance. If your rooms do not already have one, please order the correct equipotential bonding cable as well. Our team would be happy to advise you.

In the swingo-clinic equipment cart system, a POAG pin is mounted on the rear of the base plate. Retro-fitting by the customer is not possible with this cart system.

Attention:

All function carts mentioned in this price list – except basic trolleys with 1 drawer – are delivered already assembled without surcharge.

Please note: the return of disassembled items will be accepted only if the items are in perfect condition and have not been mounted!

HAEBERLE specializes in particular in providing customized OEM versions for industrial clients. Let us know your specifications and we will provide you a product according to your personal requirements. Please ask us!



Item	Description	Ref. no.	Ref. no.
------	-------------	----------	----------

swingo® 35 - special model $\hat{=}$ shelf width 350 mm

swingo® wood-plastic	swingo®- clinic metal						
<div style="border: 1px solid black; padding: 5px; width: 150px; height: 100px; display: flex; align-items: center; justify-content: center;">  </div> <p>Sonography cart</p> <p>Chassis with basic shelf, castors \varnothing 100 mm, 2 lockable, aluminium carrier profiles with standard height 645 mm, top shelf with special dimensions 350 x 550 mm (w x d) with handle at the frontside, 1 shelf 350 x 450 mm (w x d), horizontal arm, clear height between the 2 shelves: 240 mm.</p> <p>Dim.: 450 x 610 x 811 mm (w x d x h)</p>	<p>Drawer handle and decorative strips in:</p> <table border="0"> <tr><td>grey</td><td style="text-align: right;">16831</td></tr> <tr><td>blue</td><td style="text-align: right;">16832</td></tr> <tr><td>yellow</td><td style="text-align: right;">16834</td></tr> </table>	grey	16831	blue	16832	yellow	16834
grey	16831						
blue	16832						
yellow	16834						

swingo® 45 + swingo®-clinic 45 $\hat{=}$ shelf width 450 mm

Basic cart / Equipment carts

<div style="border: 1px solid black; padding: 5px; width: 150px; height: 100px; display: flex; align-items: center; justify-content: center;">  </div> <p>Basic cart</p> <p>with 1 drawer, castors \varnothing 100 mm, delivery disassembled; assembled delivery against surcharge is possible.</p> <p>Dim.: 545 x 560 x 811 mm (w x d x h)</p> <p>Push handles see on page 11.</p>	<p>Drawer handle and decorative strips in:</p> <table border="0"> <tr><td>grey</td><td style="text-align: right;">13191</td></tr> <tr><td>blue</td><td style="text-align: right;">13192</td></tr> <tr><td>yellow</td><td style="text-align: right;">13194</td></tr> </table>	grey	13191	blue	13192	yellow	13194	<p style="color: #008000;">with POAG-Pin</p> <table border="0"> <tr><td style="color: #008000;">13171</td></tr> <tr><td style="color: #008000;">13172</td></tr> <tr><td style="color: #008000;">13174</td></tr> </table>	13171	13172	13174
grey	13191										
blue	13192										
yellow	13194										
13171											
13172											
13174											



For optimal stability, each cart with carrier profile up from 957 mm and without drawers has to be equipped with one horizontal arm, ref. no. 16555. Delivery assembled without surcharge.

<div style="border: 1px solid black; padding: 5px; width: 150px; height: 100px; display: flex; align-items: center; justify-content: center;">  </div> <p>Equipment cart 1</p> <p>Chassis with castors \varnothing 100 mm, 2 lockable, horizontal arm, 4 trays 450 mm deep, 1 drawer 100 mm high.</p> <p>Dim.: 545 x 560 x 1.123 mm (w x d x h)</p> <p>Push handles see on page 11.</p>	<p>Drawer handle and decorative strips in:</p> <table border="0"> <tr><td>grey</td><td style="text-align: right;">13881</td></tr> <tr><td>blue</td><td style="text-align: right;">13882</td></tr> <tr><td>yellow</td><td style="text-align: right;">13884</td></tr> </table>	grey	13881	blue	13882	yellow	13884	<p style="color: #008000;">with POAG-Pin</p> <table border="0"> <tr><td style="color: #008000;">13691</td></tr> <tr><td style="color: #008000;">13692</td></tr> <tr><td style="color: #008000;">13694</td></tr> </table>	13691	13692	13694
grey	13881										
blue	13882										
yellow	13884										
13691											
13692											
13694											

<div style="border: 1px solid black; padding: 5px; width: 150px; height: 100px; display: flex; align-items: center; justify-content: center;">  </div> <p>Equipment cart 2</p> <p>Chassis with castors \varnothing 100 mm, 2 lockable, horizontal arm, 3 trays 450 mm deep, 1 shelf 450 mm deep, 1 drawer 100 mm high.</p> <p>Dim.: 545 x 560 x 1.123 mm (w x d x h)</p> <p>Push handles see on page 11.</p>	<p>Drawer handle and decorative strips in:</p> <table border="0"> <tr><td>grey</td><td style="text-align: right;">16871</td></tr> <tr><td>blue</td><td style="text-align: right;">16872</td></tr> <tr><td>yellow</td><td style="text-align: right;">16874</td></tr> </table>	grey	16871	blue	16872	yellow	16874	<p style="color: #008000;">with POAG-Pin</p> <table border="0"> <tr><td style="color: #008000;">13721</td></tr> <tr><td style="color: #008000;">13722</td></tr> <tr><td style="color: #008000;">13724</td></tr> </table>	13721	13722	13724
grey	16871										
blue	16872										
yellow	16874										
13721											
13722											
13724											



Item	Description	Ref. no.	Ref. no.
------	-------------	----------	----------

Endoscopy cart / Ergometry cart

		swingo® wood-plastic	swingo®-clinic metal									
<div style="border: 1px solid black; padding: 5px; margin-bottom: 10px;"> <p>Endoscopy cart</p>  </div>	<p>Chassis with 4 electrically conductive castors Ø 125 mm, 2 lockable, horizontal arm, 5 shelves 450 mm deep, 1 drawer 100 mm high.</p> <p>Dim.: 545 x 560 x 1.417 mm (w x d x h)</p> <p>Push handles see on page 11.</p>	<p>Drawer handle and decorative strips in:</p> <table border="0"> <tr><td>grey</td><td style="text-align: right;">13821</td></tr> <tr><td>blue</td><td style="text-align: right;">13822</td></tr> <tr><td>yellow</td><td style="text-align: right;">13824</td></tr> </table>	grey	13821	blue	13822	yellow	13824	<p style="color: #008000;">with POAG-Pin</p> <table border="0"> <tr><td>13081</td></tr> <tr><td>13082</td></tr> <tr><td>13084</td></tr> </table>	13081	13082	13084
grey	13821											
blue	13822											
yellow	13824											
13081												
13082												
13084												
<div style="border: 1px solid black; padding: 5px; margin-bottom: 10px;"> <p>Ergometry cart</p>  </div>	<p>Chassis with castors Ø 100 mm, 2 lockable, 1 drawer, 100 mm high, shelf 300 mm deep, cable holder ref. no.13926.</p> <p>Dim.: 545 x 560 x 1.123 mm (w x d x h)</p> <p>Push handles see on page 11.</p>	<p>Drawer handle and decorative strips in:</p> <table border="0"> <tr><td>grey</td><td style="text-align: right;">16451</td></tr> <tr><td>blue</td><td style="text-align: right;">16452</td></tr> <tr><td>yellow</td><td style="text-align: right;">16454</td></tr> </table>	grey	16451	blue	16452	yellow	16454	<p style="color: #008000;">with POAG-Pin</p> <table border="0"> <tr><td>16461</td></tr> <tr><td>16462</td></tr> <tr><td>16464</td></tr> </table>	16461	16462	16464
grey	16451											
blue	16452											
yellow	16454											
16461												
16462												
16464												

swingo® 60 + swingo®-clinic 60 ≙ shelf width 600 mm

Basic cart / Low height cart / Drawer



<div style="border: 1px solid black; padding: 5px; margin-bottom: 10px;"> <p>Basic cart</p>  </div>	<p>with 1 drawer, castors Ø 100 mm, delivery disassembled; assembled delivery against surcharge.</p> <p>Dim.: 700 x 560 x 811 mm (w x d x h)</p> <p>Push handles see on page 11.</p>	<p>Drawer handle and decorative strips in:</p> <table border="0"> <tr><td>grey</td><td style="text-align: right;">13011</td></tr> <tr><td>blue</td><td style="text-align: right;">13012</td></tr> <tr><td>yellow</td><td style="text-align: right;">13014</td></tr> </table>	grey	13011	blue	13012	yellow	13014	<p style="color: #008000;">with POAG-Pin</p> <table border="0"> <tr><td>13001</td></tr> <tr><td>13002</td></tr> <tr><td>13004</td></tr> </table>	13001	13002	13004
grey	13011											
blue	13012											
yellow	13014											
13001												
13002												
13004												
<div style="border: 1px solid black; padding: 5px; margin-bottom: 10px;"> <p>Low height cart</p>  </div>	<p>fits neatly under a treatment bed. With 1 drawer, Castors Ø 100 mm; delivery disassembled; assembled delivery against surcharge.</p> <p>Dim.: 700 x 560 x 500 mm (w x d x h)</p> <p>Push handles see on page 11.</p>	<p>Drawer handle and decorative strips in:</p> <table border="0"> <tr><td>grey</td><td style="text-align: right;">13111</td></tr> <tr><td>blue</td><td style="text-align: right;">13112</td></tr> <tr><td>yellow</td><td style="text-align: right;">13114</td></tr> </table>	grey	13111	blue	13112	yellow	13114	<p style="color: #008000;">with POAG-Pin</p> <table border="0"> <tr><td>13071</td></tr> <tr><td>13072</td></tr> <tr><td>13074</td></tr> </table>	13071	13072	13074
grey	13111											
blue	13112											
yellow	13114											
13071												
13072												
13074												
<div style="border: 1px solid black; padding: 5px; margin-bottom: 10px;"> <p>Drawer 100 mm high</p>  </div>	<p>with easy-glide telescopic guidance with engaging mechanism.</p> <p>Inner dim.: 529 x 384,5 x 74 mm (w x d x h)</p>	<p>Drawer handle:</p> <table border="0"> <tr><td>grey</td><td style="text-align: right;">13101</td></tr> <tr><td>blue</td><td style="text-align: right;">13102</td></tr> <tr><td>yellow</td><td style="text-align: right;">13104</td></tr> </table>	grey	13101	blue	13102	yellow	13104	<table border="0"> <tr><td>13211</td></tr> <tr><td>13212</td></tr> <tr><td>13214</td></tr> </table>	13211	13212	13214
grey	13101											
blue	13102											
yellow	13104											
13211												
13212												
13214												
<p>The basic model, can be equipped with up to 6 drawers, the low height cart with up to 3 drawers.</p>	<p>with completely extensible guidance.</p> <p>Inner dim.: 506 x 396 x 74 mm (w x d x h)</p>	<table border="0"> <tr><td>grey</td><td></td></tr> <tr><td>blue</td><td></td></tr> <tr><td>yellow</td><td></td></tr> </table>	grey		blue		yellow		<table border="0"> <tr><td>13211</td></tr> <tr><td>13212</td></tr> <tr><td>13214</td></tr> </table>	13211	13212	13214
grey												
blue												
yellow												
13211												
13212												
13214												

Item	Description	Ref. no.	Ref. no.
------	-------------	----------	----------

Equipment cart / Computer cart / Cart for monitoring / Endoscopy cart

Proven in practice cart combinations, that can be complemented or modified at any time. **The push handles are not included in the basic combination!** Delivery is assembled without surcharge.

swingo® wood-plastic	swingo®- clinic metal
-------------------------	--------------------------

<div style="border: 1px solid black; padding: 5px;"> <p>Equipment cart 1</p>  </div>	<p>Chassis with castors Ø 100 mm, 2 lockable, load capacity up to 130 kg. 4 shelves 450 mm deep, 1 drawer 100 mm high, 1 horizontal arm.</p> <p>Dim.: 700 x 560 x 1.123 mm (w x d x h)</p> <p>Push handles see on page 11.</p>	<p>Drawer handle and decorative strips in:</p> <table border="0"> <tr><td>grey</td><td style="text-align: right;">13671</td></tr> <tr><td>blue</td><td style="text-align: right;">13672</td></tr> <tr><td>yellow</td><td style="text-align: right;">13674</td></tr> </table>	grey	13671	blue	13672	yellow	13674	<p style="color: green;">with POAG-Pin</p> <table border="0"> <tr><td style="text-align: right;">13681</td></tr> <tr><td style="text-align: right;">13682</td></tr> <tr><td style="text-align: right;">13684</td></tr> </table>	13681	13682	13684
grey	13671											
blue	13672											
yellow	13674											
13681												
13682												
13684												
<div style="border: 1px solid black; padding: 5px;"> <p>Computer cart new</p>  </div>	<p>Chassis with basic shelf, 300 mm deep and castors Ø 100 mm, 2 lockable, carrier profiles in standard height of 645 mm, 1 shelf on top. Pull-out shelf for keyboard with mouse pad, extensible to the right or left side, PC support mounted on the left side, TFT mount with horizontal arm.</p> <p>Dim.: 700 x 560 x 811 mm (w x d x h)</p> <p>Height min. 967 mm with TFT mount</p> <p>Push handles see on page 11.</p>	<p>Decorative strips in:</p> <table border="0"> <tr><td>grey</td><td style="text-align: right;">16921</td></tr> <tr><td>blue</td><td style="text-align: right;">16922</td></tr> <tr><td>yellow</td><td style="text-align: right;">16924</td></tr> </table>	grey	16921	blue	16922	yellow	16924	<p style="color: green;">with POAG-Pin</p> <table border="0"> <tr><td style="text-align: right;">16931</td></tr> <tr><td style="text-align: right;">16932</td></tr> <tr><td style="text-align: right;">16934</td></tr> </table>	16931	16932	16934
grey	16921											
blue	16922											
yellow	16924											
16931												
16932												
16934												
<div style="border: 1px solid black; padding: 5px;"> <p>Cart for monitoring new</p>  </div>	<p>Chassis with castors Ø 125 mm, 2 lockable, carrier profiles in standard height of 1218 mm, 1 drawer 100 mm, high, 4 shelves, pull-out shelf for keyboard with mouse pad, extensible to the right or left side, TFT mount with horizontal arm.</p> <p>Dim.: 700 x 560 x 1.417 mm (w x d x h)</p> <p>Height min. 1519 mm with TFT mount</p> <p>Push handles see on page 11.</p>	<p>Decorative strips in:</p> <table border="0"> <tr><td>grey</td><td style="text-align: right;">16941</td></tr> <tr><td>blue</td><td style="text-align: right;">16942</td></tr> <tr><td>yellow</td><td style="text-align: right;">16944</td></tr> </table>	grey	16941	blue	16942	yellow	16944	<p style="color: green;">with POAG-Pin</p> <table border="0"> <tr><td style="text-align: right;">16951</td></tr> <tr><td style="text-align: right;">16952</td></tr> <tr><td style="text-align: right;">16954</td></tr> </table>	16951	16952	16954
grey	16941											
blue	16942											
yellow	16944											
16951												
16952												
16954												
<div style="border: 1px solid black; padding: 5px;"> <p>Endoscopy cart</p>  </div>	<p>Chassis with 4 electrically conductive castors Ø 150 mm, 2 lockable, maximum load capacity 250 kg. 5 shelves 450 mm deep, 1 drawer 100 mm high, 1 horizontal arm for multiple socket outlet.</p> <p>Dim.: 700 x 560 x 1.445 mm (w x d x h)</p> <p>Push handles see on page 11.</p>	<p>Drawer handle and decorative strips in:</p> <table border="0"> <tr><td>grey</td><td style="text-align: right;">13841</td></tr> <tr><td>blue</td><td style="text-align: right;">13842</td></tr> <tr><td>yellow</td><td style="text-align: right;">13844</td></tr> </table> <p>Holding device for endoscopes (see on page 21)</p>	grey	13841	blue	13842	yellow	13844	<p style="color: green;">with POAG-Pin</p> <table border="0"> <tr><td style="text-align: right;">13371</td></tr> <tr><td style="text-align: right;">13372</td></tr> <tr><td style="text-align: right;">13374</td></tr> </table>	13371	13372	13374
grey	13841											
blue	13842											
yellow	13844											
13371												
13372												
13374												

Item	Description	Ref. no.	Ref. no.
------	-------------	----------	----------

Endoscopy cart / MIC-cart / Ergometry cart / Injection cart

		swingo® wood-plastic		swingo®- clinic metal
 <p>Endoscopy cart 60.2</p>	<p>Chassis with electrically conductive castors Ø 150 mm, 2 lockable. Basic shelf, 4 shelves 450 mm deep, 1 push handle, short, 1 extensible shelf. Drawer 100 mm high, horizontal arm. Base frame isolation transformer, 2200 VA, central switch (inside of column), lateral endoscope holder with endoscope tube, closed at the bottom.</p> <p>Dim.: 700 x 560 x 1.445 mm (w x d x h)</p>	<p>Drawer handle and decorative strips in:</p> <p>grey blue yellow</p>	<p>with POAG-Pin</p> <p>16851 16852 16854</p>	
 <p>MIC-cart</p>	<p>Chassis with basic shelf extended to the back and electrically conductive castors Ø 150 mm, 2 lockable, load capacity up to 250 kg, including horizontal arm and anti-sliding mat. 5 shelves 450 mm deep, 1 drawer 100 mm high, 1 holder for oxygen bottle 5/10 litres, 1 multiple socket outlet with 4 sockets.</p> <p>Dim.: 700 x 560 x 1.445 mm (w x d x h)</p> <p>Push handles see on page 11.</p>	<p>Drawer handle and decorative strips in:</p> <p>grey blue yellow</p>	<p>13851 13852 13854</p>	<p>with POAG-Pin</p> <p>13461 13462 13464</p>
 <p>Ergometry-/stimulant current cart</p>	<p>Chassis with castors Ø 100 mm, 2 lockable, aluminium carrier profiles with standard height of 1218 mm. Drawer 100 mm high. Upper shelf 300 mm deep, cable holder ref. no. 13926.</p> <p>Dim.: 700 x 560 x 1.384 mm (w x d x h)</p> <p>Push handles see on page 11.</p>	<p>Drawer handle and decorative strips in:</p> <p>grey blue yellow</p> <p><u>Recommended accessories:</u></p> <p>Additional shelf, 300 mm deep (see on page 14)</p>	<p>13331 13332 13334</p> <p>13905</p>	<p>with POAG-Pin</p> <p>13381 13382 13384</p> <p>13944</p>
 <p>Injection cart PicBox®Plus</p>	<p>Chassis with castors Ø 100 mm, 2 lockable, aluminium carrier profiles with standard height of 1218 mm. Drawer 100 mm high. Drawer insert with variable partitions. PicBox® injection set and KOMBI set. Schluckfix canula container (set with 20 boxes). Waste container with stainless steel bowl, arm support.</p> <p>Dim.: 780 x 560 x 1.384 mm (w x d x h)</p> <p>Push handles see on page 11.</p>	<p>Drawer handle and decorative strips in:</p> <p>grey blue yellow</p> <p><u>Recommended accessories:</u></p> <p>CUPFIX ampoule opener</p> <p>Examination lamp (see on page 22)</p>	<p>13321 13322 13324</p> <p>13921</p>	<p>with POAG-Pin</p> <p>13391 13392 13394</p> <p>13921</p>

Item	Description	Ref. no.	Ref. no.
Injection cart / Emergency carts / Anaesthesia cart			
 <p>Injection cart COMPACT</p>	<p>Chassis with castors Ø100 mm, 2 lockable, aluminium carrier profiles with standard height of 1218 mm. Drawer 100 mm high. Drawer insert with variable partitions. COMPACT injection set. canula container "Medi-Müll" (set with 20 boxes). Arm rest. Waste container with stainless steel bowl.</p> <p>Dim.: 970 x 560 x 1.384 mm (w x d x h)</p> <p>Push handles see on page 11.</p>	<p>swingo® wood-plastic</p> <p>Drawer handle and decorative strips in:</p> <p>grey 13311 blue 13312 yellow 13314</p> <p><u>Recommended accessory:</u></p> <p>CUPFIX ampoule opener 13921 (see on page 21)</p>	<p>swingo®-clinic metal</p> <p>with POAG-Pin</p> <p>13481 13482 13484</p> <p>13921</p>
 <p>Emergency cart 1</p>	<p>Chassis with 4 electrically conductive castors Ø 150 mm, 2 lockable, maximum load capacity 250 kg. Stainless steel tray 450 mm deep. 2 drawers 100 mm high. 1 drawer 200 mm high.</p> <p>Dim.: 700 x 560 x 873 mm (w x d x h)</p> <p>Push handles see on page 11.</p>	<p>Drawer handle and decorative strips in:</p> <p>grey 13521 blue 13522 yellow 13524</p> <p><u>Recommended accessory:</u></p> <p>Reanimation board with holder 17370 (see on page 21)</p> <p>Single use seal 13958 (see on page 13)</p>	<p>with POAG-Pin</p> <p>13361 13362 13364</p> <p>17370</p> <p>13958</p>
 <p>Emergency cart 2</p>	<p>Chassis with 4 electrically conductive castors Ø 150 mm, 2 lockable, maximum load capacity 250 kg. Shelf 300 mm deep with anti-sliding mat for defibrillator, stainless steel tray, 450 mm deep, 2 drawers 100 mm high, 1 drawer 200 mm high.</p> <p>Dim.: 700 x 560 x 1.185 mm (w x d x h)</p> <p>Push handles see on page 11.</p>	<p>Drawer handle and decorative strips in:</p> <p>grey 13831 blue 13832 yellow 13834</p> <p><u>Recommended accessory:</u></p> <p>Reanimation board with holder 17370 (see on page 21)</p> <p>Single use seal 13958 (see on page 13)</p>	<p>with POAG-Pin</p> <p>13421 13422 13424</p> <p>17370</p> <p>13958</p>
 <p>Anaesthesia cart</p>	<p>Chassis with basic shelf and 4 electrically conductive castors Ø 125 mm, 2 lockable, maximum load capacity 130 kg. 5 drawers 100 mm high, gallery.</p> <p>Dim.: 700 x 560 x 896 mm (w x d x h)</p> <p>Push handles see on page 11.</p>	<p>Drawer handle and decorative strips in:</p> <p>grey 13861 blue 13862 yellow 13864</p>	<p>with POAG-Pin</p> <p>13441 13442 13444</p>

Item	Description	Ref. no.	Ref. no.
------	-------------	----------	----------

Gynaecology cart / Writing desk cart / Standing desk cart / Diaper-changing table cart / Changing mat

swingo®
wood-plastic

swingo®- clinic
metal

Gynaecology cart



Basic cart with castors Ø 100 mm, 2 lockable. Drawer 100 mm high, heated drawer 100 mm high. Drawer insert with variable partitions. Waste container with stainless steel bowl, waste container for instruments with polypropylene bowl. The lamp is not included in this configuration.

Dim.:
700 x 560 x 811 mm (w x d x h)

Push handles see on page 11.

Drawer handle and decorative strips in:

grey **13341**
blue **13342**
yellow **13344**

Recommended accessories:

Multiple socket outlet, with 4-fold, standard **21693**

LED examination lamp (separately on page 22).

Attention: If you order a lamp, then only 1 push handle is possible.

Writing desk cart



Chassis with basic shelf 300 mm deep and castors Ø 100 mm, 2 lockable. Shelf with adjustable inclination 450 mm deep with antislip edge, drawer 100 mm high, shelf 450 mm deep, drawer insert with variable partitions, writing height: approx. 1040 mm.

Dim.:
700 x 560 x 1.123 mm (w x d x h)

Push handles see on page 11.

Drawer handle and decorative strips in:

grey **13661**
blue **13662**
yellow **13664**

with POAG-Pin

13451
13452
13454

Standing desk cart



Chassis with basic shelf 300 mm deep and castors Ø 100 mm, 2 lockable, 1 drawer 100 mm high. Desk attachment consisting of: angled writing board, dim.: 600 x 450 mm (w x d), utensil insert and pencil holder, storage compartment, clear height (front): approx. 200 mm, writing height: approx. 1030 mm.

Dim. of the cart:
700 x 560 x 1.150 mm (w x d x h)

Push handles see on page 11.

Drawer handle and decorative strips in:

grey **13351**
blue **13352**
yellow **13354**

Diaper-changing table cart



Chassis with castors Ø 100 mm, 2 lockable, aluminium carrier profiles with standard height of 645 mm. Upholstered swaddling surface (alternating pattern), shelf for accessories, drawer 200 mm high, at the right side basket for cream or powder, on the left side waste collector "tomo".

Dim.:
700 x 750 x 928 mm (w x d x h)

separately (varying designs)

Drawer handle and decorative strips in:

grey **12261**
blue **12262**
yellow **12264**

Changing mat

14875

System parts for **swingo + swingo-clinic 45 and 60**

Chassis

The reference numbers of the system parts include the complete fastening elements. Delivery of individually configured and assembled carts is free of surcharge.

for cart 45

Chassis 45 with basic shelf



Attention:

For optimal stability each cart has to be equipped with at least 1 drawer or 1 horizontal arm, ref. no. 16555, see on page 17.

Shelf: 450 x 450 mm (w x d)

Dim.: 545 x 560 mm (w x d)

✗ Castors Ø 100 mm, with grey bumpers

swingo® wood-plastic Ref. no.	swingo®-clinic metal ✗ Ref. no.
13130	13100

✗ Castors Ø 125 mm, 2 of them lockable

13120	13110
-------	-------

for cart 60

Chassis 60 with basic shelf



Attention

For optimal stability each cart has to be equipped with at least 1 drawer or 1 horizontal arm, ref. no. 16555, see on page 17.

Shelf: 600 x 450 mm (w x d)

Dim.: 700 x 560 mm (w x d)

✗ Castors Ø 100 mm, with grey bumpers

swingo® wood-plastic Ref. no.	swingo®-clinic metal ✗ Ref. no.
13300	13600

✗ Castors Ø 125 mm, 2 of them lockable

13200	13500
-------	-------

✗ Castors Ø 150 mm, electrically conductive, 2 of them lockable

13400	13700
-------	-------

Chassis 60 enlarged towards the back



for supporting oxygen bottles, incl. horizontal arm and anti-sliding-mat for secure holding.

Shelf: 600 x 450 mm (w x d)

Dim.: 700 x 710 mm (w x d)

✗ Castors Ø 150 mm, electrically conductive, 2 of them lockable

swingo® wood-plastic Ref. no.	swingo®-clinic metal ✗ Ref. no.
13900	13800

Chassis 45 with 300 mm shelf



The **300 mm deep** shelf is suitable for seated and standing activities.

Shelf: 450 x 300 mm (w x d)

Dim.: 545 x 560 mm (w x d)

✗ Castors Ø 100 mm, with grey bumpers

swingo® wood-plastic Ref. no.	swingo®-clinic metal ✗ Ref. no.
16671	16672

Chassis 60 with 300 mm shelf



The **300 mm deep** shelf is suitable for seated and standing activities.

Shelf: 600 x 300 mm (w x d)



Dim.: 700 x 560 mm (w x d)

✗ Castors Ø 100 mm, with grey bumpers

swingo® wood-plastic Ref. no.	swingo®-clinic metal ✗ Ref. no.
16673	16674

Item	Description	Ref. no.	Ref. no.
------	-------------	----------	----------



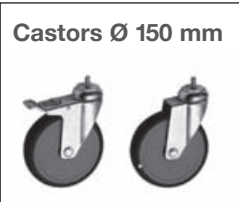

Castors / Carrier profiles

		swingo® wood-plastic	swingo®- clinic metal
 <p>Castors Ø 100 mm</p>	Surcharge for 2 lockable plastic castors Ø 100 mm, load capacity up to 130 kg electrically conductive: surcharge for 4 plastic castors Ø 100 mm, 2 lockable, load capacity up to 130 kg.	13906	13906
		13907	13907
 <p>Castors Ø 125 mm</p>	Surcharge for plastic castors Ø 125 mm, 2 lockable, load capacity up to 130 kg. electrically conductive: surcharge for 4 plastic castors Ø 125 mm, 2 lockable, load capacity up to 130 kg.	13938	13938
		13939	13939
 <p>Castors Ø 150 mm</p>	Surcharge for 4 metal castors Ø 150 mm, 2 lockable, load capacity up to 250 kg. electrically conductive: surcharge for 4 metal castors Ø 150 mm, 2 lockable, load capacity up to 250 kg.	15702	15702
		13940	13940

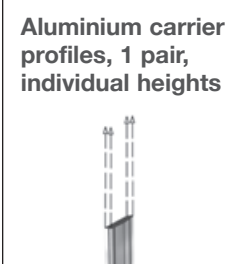
For the guarantee of an optimal stability **each cart with carrier profiles up from 957 mm and without drawers** has to be equipped with one horizontal arm (45/60), ref. no. 16555 or ref. no. 16554. See on page 16.

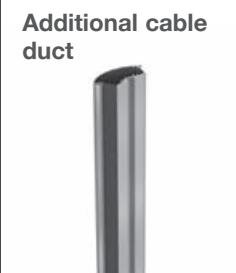
 <p>Aluminium carrier profiles, 1 pair, standard heights</p>	Strong and stable, with integrated cable duct and decorative strips in different colours in grey, blue or yellow. The total height of the cart depends on the size of the castors.	Height 645 mm decorative strips:		
		grey	13611	13611
		blue	13612	13612
		yellow	13614	13614
		Height 801 mm decorative strips:		
		grey	16681	16681
		blue	16682	16682
		yellow	16684	16684
		Height 957 mm decorative strips:		
		grey	13711	13711
		blue	13712	13712
		yellow	13714	13714
		Height 1217 mm decorative strips:		
grey	13621	13621		
blue	13622	13622		
yellow	13624	13624		

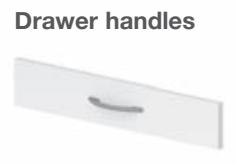
 <p>Aluminium carrier profiles, 1 pair, individual heights</p>	Please state measurements in 52 mm steps.			
	The total height of the cart depends on the size of the castors. Please take door heights into account.			
	height \ colours	grey	blue	yellow
	0 – 645 mm	13731	13732	13734
	0 – 1217 mm	13741	13742	13744
0 – 1841 mm	13751	13752	13754	

Item	Description	Ref. no.	Ref. no.
Additional cable duct / Push handles / Drawer handles			
		swingo® wood-plastic	swingo®-clinic metal
 <p>Additional cable duct</p>	<p>Offers additional space for different cables.</p> <p>Elegant aluminium profile fitting to swingo®-profile. Mounting at the rear of the shelf or at the right or left side of the shelf.</p> <p>Price per piece</p>	<p>Please indicate the height in your order.</p> <p>height 957 mm 16187</p> <p>height 1217 mm 16180</p> <p>individual height 1841 mm 16182</p>	<p>16187</p> <p>16180</p> <p>16182</p>
 <p>Push handle</p>	<p>Exclusive metal design, high quality laminate.</p> <p>Price per piece</p> <p>Attention: The cart will be approx. 50 mm wider with 1 handle.</p>	<p>Colour:</p> <p>grey 13801</p> <p>blue 13802</p> <p>yellow 13804</p>	<p>13801</p> <p>13802</p> <p>13804</p>
 <p>Push handle, short</p>	<p>Exclusive metal design, high quality laminate. For mounting at the front side of a shelf.</p> <p>Dim.: 260 x 60 x 20 mm</p> <p>Price per piece</p>	<p>Colour:</p> <p>grey 16166</p> <p>blue 16167</p>	<p>16166</p> <p>16167</p>
 <p>Drawer handles</p>	<p>Ergonomic designer handles in 6 different colours.</p> <p>Price per piece</p>	<p>Colour:</p> <p>grey 13161</p> <p>blue 13162</p> <p>red violet 13163</p> <p>yellow 13164</p> <p>turquoise 13165</p> <p>white 13166</p> <p>black 13167</p>	<p>13161</p> <p>13162</p> <p>13163</p> <p>13164</p> <p>13165</p> <p>13166</p> <p>13167</p>
 <p>Drawer handle</p>	<p>made of ABS plastic with label window.</p>	<p>Colour:</p> <p>grey 20061</p>	<p>20061</p>

Drawers

Please order a **drawer cover** for the top drawer. See on page 14.

for cart 45

Drawer 45



100 mm high for mounting beneath a shelf. With easy-gliding telescopic guidance and engaging mechanism.

Inner dim. swingo®:
378 x 384 x 85 mm (w x d x h)

Inner dim. swingo®-clinic:
356 x 396 x 85 mm (w x d x h)

swingo® wood-plastic		swingo®-clinic metal	
Handle	Ref. no.	Ref. no.	
grey	13181	13891	
blue	13182	13892	
yellow	13184	13894	
turquoise	13185	13895	

for cart 60

Drawer 60



100 mm high for mounting beneath a shelf. With easy-gliding telescopic guidance and engaging mechanism.

Inner dim. swingo®:
529 x 384 x 85 mm (w x d x h)

Inner dim. swingo®-clinic:
506 x 396 x 85 mm (w x d x h)

swingo® wood-plastic		swingo®-clinic metal	
Handle	Ref. no.	Ref. no.	
grey	13101	13211	
blue	13102	13212	
yellow	13104	13214	
turquoise	13105	13215	

Drawer 45



200 mm high for mounting beneath a shelf. With easy-gliding telescopic guidance and engaging mechanism.

Inner dim. swingo®:
378 x 384 x 190 mm (w x d x h)

Inner dim. swingo®-clinic:
356 x 396 x 190 mm (w x d x h)

swingo® wood-plastic		swingo®-clinic metal	
Handle	Ref. no.	Ref. no.	
grey	16001	16011	
blue	16002	16012	
yellow	16004	16014	
turquoise	16005	16015	

Drawer 60



200 mm high for mounting beneath a shelf. With rail, easy-gliding telescopic guidance and engaging mechanism.

Inner dim. swingo®:
529 x 384 x 190 mm (w x d x h)

swingo® wood-plastic		swingo®-clinic metal	
Handle	Ref. no.	Ref. no.	
grey	13201		
blue	13202		
yellow	13204		
turquoise	13205		

Drawer 60



200 mm high, with rail, easy-gliding telescopic guidance and engaging mechanism.

Inner dim. swingo®-clinic:
506 x 396 x 190 mm (w x d x h)

swingo®-clinic metal	
Handle	Ref. no.
grey	13221
blue	13222
yellow	13224
turquoise	13225

Surcharge for lockable drawers 45

100 mm high

swingo® wood-plastic		swingo®-clinic metal	
Ref. no.		Ref. no.	
13994		15869	

200 mm high

swingo® wood-plastic		swingo®-clinic metal	
Ref. no.		Ref. no.	
13995		15869	

Surcharge for lockable drawers 60

100 mm high

swingo® wood-plastic		swingo®-clinic metal	
Ref. no.		Ref. no.	
13962		15003	

200 mm high

swingo® wood-plastic		swingo®-clinic metal	
Ref. no.		Ref. no.	
13990		15003	

Heatable drawer / Drawer insets

for cart 45

Drawer inset 45



with variable partitions and flexible dividers with 1 lengthway divider and 4 crossway dividers. Made of transparent synthetic material, removable and suitable for cleaning in the dishwasher.

for **swingo®**
Dim.: 377 x 384 x 58 mm (w x d x h)
 for **swingo®-clinic**
Dim.: 356 x 389 x 58 mm (w x d x h)

swingo® wood-plastic	swingo®-clinic metal
Ref. no.	Ref. no.
16720	16722

for cart 60

Drawer 60 heatable



100 mm high, 450 mm deep.

Dim. of the heatable surface:
526 x 381 x 37 mm (w x d x h)

for **swingo®**

swingo® wood-plastic	
Handle Ref. no.	
grey 13401	
blue 13402	
yellow 13404	
turquoise 13405	

Drawer inset 60



with variable partitions and flexible dividers with 2 lengthway dividers and 6 crossway dividers. Made of transparent synthetic material, removable and suitable for cleaning in the dishwasher.

for **swingo®**
Dim.: 529 x 384 x 58 mm (w x d x h)
 for **swingo®-clinic**
Dim.: 506 x 389 x 58 mm (w x d x h)

swingo® wood-plastic	swingo®-clinic metal
Ref. no.	Ref. no.
16719	16721

Anti-tamper seals / PC supports

Anti-tamper seal



for up to 3 drawers; made of metal, powder-coated, grey-white (RAL 9002).
 – without single use seal –

Dim.: 57 x 95 x 260 mm (w x d x h)

swingo® wood-plastic	swingo®-clinic metal
Ref. no.	Ref. no.
13958	13958

Single use seal, plastic, blue for single use per 100 pieces.

13998	13998
--------------	--------------

Anti-tamper seal



for up to 3 drawers; made of metal, powder-coated, grey-white (RAL 9002).
 – without single use seal –

Dim.: 57 x 95 x 260 mm (w x d x h)

swingo® wood-plastic	swingo®-clinic metal
Ref. no.	Ref. no.
13958	13958

Single use seal, plastic, blue for single use per 100 pieces.

13998	13998
--------------	--------------

PC support



for fastening sideways to the right or left side of the carrier profile, with fixing strip. Suitable for all conventional models, as the mount is vertically adjustable.

Steel, powder-coated, white aluminium (RAL 9006).

swingo® wood-plastic	swingo®-clinic metal
Ref. no.	Ref. no.
right 16339	16339
left 16345	16345

PC support



for fastening sideways to the right or left side of the carrier profile, with fixing strip. Suitable for all conventional models, as the mount is vertically adjustable.

Steel, powder-coated, white aluminium (RAL 9006).

swingo® wood-plastic	swingo®-clinic metal
Ref. no.	Ref. no.
right 16339	16339
left 16345	16345

Shelves / Pull-out shelves

for cart 45

Shelf 300 mm deep

22 mm thick, **width 450 mm**.

Colour for
swingo®: white
swingo®-clinic: grey-white RAL 9002

swingo® wood-plastic	swingo®-clinic metal
Ref. no.	Ref. no.
14692	14973

Shelf 450 mm deep

22 mm thick, **width 450 mm**. To be used as **cover for drawer** or **storage shelf**.

Colour for
swingo®: white
swingo®-clinic: grey-white RAL 9002

swingo® wood-plastic	swingo®-clinic metal
Ref. no.	Ref. no.
14691	14693

Pull-out shelf 45



for keyboard, printer or other devices, approx. 22 mm thick, incl. grey handle. Load capacity up to 10 kg.

Dim.: 450 x 450 mm (w x d)

Colour for
swingo®-clinic: grey-white RAL 9002

swingo®-clinic metal
Ref. no.
16712

for cart 60

Shelf 300 mm deep

22 mm thick, **width 600 mm**.

Colour for
swingo®: white
swingo®-clinic: grey-white RAL 9002

swingo® wood-plastic	swingo®-clinic metal
Ref. no.	Ref. no.
13905	13944

Shelf, stainless steel 450 mm deep



with contoured edge, 25 mm thick, 7 mm high. **Width 600 mm**. Insensitive, easy-to-clean linen structure.

Storage space: 570 x 450 mm (w x d)

swingo® wood-plastic	swingo®-clinic metal
Ref. no.	Ref. no.
14710	14710

Shelf 450 mm deep



22 mm thick, **width 600 mm**. To be used as **cover for drawer** or **storage shelf**.

Colour for
swingo®: white
swingo®-clinic: grey-white RAL 9002

swingo® wood-plastic	swingo®-clinic metal
Ref. no.	Ref. no.
13904	13942

Shelf 300 mm deep inclinable

22 mm thick, **width 600 mm**. To be used as **cover for drawer** or **storage shelf**.

Colour for
swingo®: white
swingo®-clinic: grey-white RAL 9002

swingo® wood-plastic	swingo®-clinic metal
Ref. no.	Ref. no.
13965	13946

Shelf 450 mm deep inclinable



22 mm thick, **width 600 mm**. Maximum angle of inclination 20°. Ideally suited for monitors or as writing desk. Load capacity up to 10 kg.

Colour for
swingo®: white
swingo®-clinic: grey-white RAL 9002

swingo® wood-plastic	swingo®-clinic metal
Ref. no.	Ref. no.
13964	13945

Pull-out shelf 60



for keyboard, printer or other devices, approx. 32 mm thick, incl. grey handle. Load capacity up to 10 kg.

Dim.: 600 x 450 mm (w x d)

Colour for
swingo®-clinic: grey-white RAL 9002

swingo®-clinic metal
Ref. no.
16703

Pull-out shelf / Anti-slide mats / Lateral shelves / Top panels

for cart 45

for cart 60

Pull-out shelf 60



for keyboard with mouse pad, extensible to the right or left side; about 32 mm thick, handle grey. Load capacity up to 10 kg.

Dim.: 600 x 450 mm (w x d)

Colour for **swingo®clinic**: grey-white RAL 9002

swingo®-clinic metal
Ref. no.
16715

Anti-slide mat for shelves 45

Made of a copolymer of ethylene and vinyl acetate (EVA), transparent, noise absorbing.

Dim.: 450 x 450 mm (w x d)

swingo® wood-plastic	swingo®-clinic metal
Ref. no.	Ref. no.
15541	15541

Dim.: 450 x 300 mm (w x d)

16161	16161
--------------	--------------

Anti-slide mat for shelves 60

Made of a copolymer of ethylene and vinyl acetate (EVA), transparent, noise absorbing.

Dim.: 600 x 450 mm (w x d)

swingo® wood-plastic	swingo®-clinic metal
Ref. no.	Ref. no.
13950	13950

Dim.: 600 x 300 mm (w x d)

13949	13949
--------------	--------------

Lateral shelf

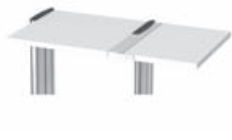

foldable, mounted on the right or left side of the carrier profile. Load capacity up to 15 kg.

Dim.: 350 x 450 mm (w x d)

swingo® wood-plastic	swingo®-clinic metal
Ref. no.	Ref. no.
13996	13997

Lateral shelf



foldable, mounted on the right or left side of the carrier profile. Load capacity up to 15 kg.

Dim.: 350 x 450 mm (w x d)

swingo® wood-plastic	swingo®-clinic metal
Ref. no.	Ref. no.
13996	13997

Top panel 45



with 10 mm raised edges, white aluminium (RAL 9006), powder-coated.

Dim.: 450 x 450 x 10 mm (w x d x h)

swingo® wood-plastic	swingo®-clinic metal
Ref. no.	Ref. no.
13991	13991

Top panel 60



with 10 mm raised edges, white aluminium (RAL 9006), powder-coated.

Dim.: 600 x 450 x 10 mm (w x d x h)

swingo® wood-plastic	swingo®-clinic metal
Ref. no.	Ref. no.
13992	13992

Gallery / Console for monitor / Holder for the console / Horizontal arms

for cart 45

for cart 60

Console for monitor



Sheet steel plate for swivel arm, white aluminium coated (RAL 9006). Up to 15 kg load capacity with sufficient counter load in the equipment carrier.

Dim.: 350 x 350 x 10 mm (w x d x h)

Other measurements are possible. Please ask us!

- Discontinued model -

Console for monitor



Sheet steel plate for swivel arm, white aluminium coated (RAL 9006). Up to 15 kg load capacity with sufficient counter load in the equipment carrier.

Dim.: 350 x 350 x 10 mm (w x d x h)

Other measurements are possible. Please ask us!

- Discontinued model -

swingo® wood-plastic	swingo®-clinic metal
Ref. no.	Ref. no.
13952	13952

swingo® wood-plastic	swingo®-clinic metal
Ref. no.	Ref. no.
13952	13952

Holder for the console



rotatable, for fastening at the carrier profile or on a horizontal arm, white aluminium (RAL 9006).

Please order the console for monitor ref. no. 13952 separately.

- Discontinued model -

Holder for the console



rotatable, for fastening at the carrier profile or on a horizontal arm, white aluminium (RAL 9006).

Please order the console for monitor ref. no. 13952 separately.

- Discontinued model -

swingo® wood-plastic	swingo®-clinic metal
Ref. no.	Ref. no.
16359	16359

swingo® wood-plastic	swingo®-clinic metal
Ref. no.	Ref. no.
16359	16359

For the guarantee of an optimal stability, **each cart with carrier profiles up from 957 mm and without drawers** has to be equipped with one horizontal arm (45/60), ref. no. 16555 or 16554.

Horizontal arm 45 metal



for additional stability of the cart; offers the possibility to fix a standard rail or a multiple socket outlet at the front or at the rear. Made of metal, white aluminium (RAL 9006), powder-coated.

Dim.: 450 x 20 x 100 mm (w x d x h)

Horizontal arm 60 metal



for additional stability of the cart; offers the possibility to fix a standard rail or a multiple socket outlet at the front or at the rear. Made of metal, white aluminium (RAL 9006), powder-coated.

Dim.: 601 x 20 x 100 mm (w x d x h)

swingo® wood-plastic	swingo®-clinic metal
Ref. no.	Ref. no.
16555	16555

swingo® wood-plastic	swingo®-clinic metal
Ref. no.	Ref. no.
16554	16554

Horizontal arms / Rails / Supporting plates for multiple socket outlet / Rear panel

for cart 45

Horizontal arm 45, wood-plastic



as additional upstand of the plate or tilt protection.
Not suitable as stabilisation.

white

Dim.: 450 x 20 x 110 mm (w x d x h)

swingo® wood-plastic	
Ref. no.	
13984	

for cart 60

Horizontal arm 60, wood-plastic



as additional upstand of the plate or tilt protection.
Not suitable as stabilisation.

white

Dim.: 601 x 20 x 110 mm (w x d x h)

swingo® wood-plastic	
Ref. no.	
13983	

Rail 45



for storage plate, **450 mm wide**, 450 mm deep, white aluminium (RAL 9002), powder-coated, Ø 8 mm. Mounted at the carrier profiles.

swingo® wood-plastic	swingo®-clinic metal
Ref. no.	Ref. no.
16646	16646

Rail 60



for storage plate, **600 mm wide**, 450 mm deep, white aluminium (RAL 9002), powder-coated, Ø 8 mm. Mounted at the carrier profiles.

swingo® wood-plastic	swingo®-clinic metal
Ref. no.	Ref. no.
16648	16648

Supporting plate 45



for multiple socket outlet. Made of metal, grey-white (RAL 9002), powder-coated; mountable at the rear, at the inner side or below at the profile. **Not suitable as stabilisation of the cart.**

Dim.: 450 x 12 x 60 mm (w x d x h)

swingo® wood-plastic	swingo®-clinic metal
Ref. no.	Ref. no.
16235	16235

Supporting plate 60



for multiple socket outlet. Made of metal, grey-white (RAL 9002), powder-coated; mountable at the rear, at the inner side or below at the profile. **Not suitable as stabilisation of the cart.**

Dim.: 600 x 12 x 60 mm (w x d x h)

swingo® wood-plastic	swingo®-clinic metal
Ref. no.	Ref. no.
16236	16236

Rear panel 60 for basic model



made of sturdy metal, white (RAL 9010) with click-in mechanism.

Dim.: 600 x 645 mm (w x h)

Please order together with the cart, because no retrofitting possible.

Rear panel in special dimensions on request.

swingo® wood-plastic	swingo®-clinic metal
Ref. no.	Ref. no.
14714	14714

Accessories for **swingo**[®] + **swingo**[®]-clinic 45 and 60

Waste collectors / Waste containers / TFT mounts / Mount for tablet/iPad

The reference numbers contain the accessory part complete with attachment fittings. All accessories can easily be fitted at the **swingo**[®] and **swingo**[®]-clinic carts.

Waste collector "tomo"



Made of smooth and easy to clean plastic (100% polypropylene), grey (RAL 7045), with detachable, well closing lid and with mount. Capacity 10 litres (for disposable bags approx. w 450 x h 350 mm).

Dim.:
315 x 180 x 315 mm (w x d x h)

Ref. no. **14097**

for standard profile rail
Ref. no. **14066**

Waste collector "tango"



with practical knee operated opening system, body in ABS plastic, white (RAL 9016), fixing material included.

Capacity 8 litres.

Dim.:
220 x 220 x 360 mm (w x d x h)

Ref. no. **16701**

Capacity 20 litres.

Dim.:
350 x 250 x 520 mm (w x d x h)

Ref. no. **16702**

For fixing at the cart, please order 2 standard profile rails, ref. no. 13924 separately. (See on page 21).

Waste container for instruments



with white polypropylene bowl and with mount, can be sterilized up to 134 °C.

Dim.:
300 x 230 x 130 mm (w x d x h)
with slit lid
Ref. no. **13912**

without slit lid
Ref. no. **13960**

Waste container



Stainless steel, bowl Ø 320 mm, with attachment device.

Ref. no. **13911**

TFT mount



for flat screens (VESA standard 75 and 100), attached to a height-adjustable rod. Installation sideways at the profile or at horizontal arm. Please order horizontal arm separately.

Load capacity up to 15 kg
Ref. no. **16346**

Swivel arm with TFT mount



for flat screens (VESA standard 75 and 100), white aluminium (RAL 9006). Inclunable and swivable. Swiveling range 300 mm.

Load capacity up to 12 kg
Ref. no. **16638**

Mount for tablet/iPad



for mounting on horizontal arm and only factory mounted. Anodised aluminium, adjustable from 7" to 10" Horizontally and vertically rotatable and tiltable, with theft protection.

Please order the **horizontal arm** separately. (See on page 17).

Dim.:
123 x 97 x 338 mm (w x d x h)

Ref. no. **20849**

new

“alegro” Monitor carrier system

For stepless and precise fixation without any physical exertion. Horizontally and vertically rotatable, tilting and swiveling function. Monitor adaption VESA 75/100.

“alegro”
monitor holder



on tightly adjusted stainless steel-rod in the carrier profile. Height above the profile approx. 400 mm.

Load capacity up to 12 kg
Ref. no. **25023**

Load capacity up to 18 kg
Ref. no. **25049**

“alegro”
holder for
double monitoring



on aluminium-traverse between two carrier profiles for precise synchronous positioning. Cable duct inside the profiles.

for **cart 60**

Load capacity up to 2 x 12 kg
Ref. no. **25003**

Load capacity up to 2 x 18 kg
Ref. no. **25029**

“alegro”
monitor holder



on aluminium-traverse between two carrier profiles. Cable duct inside the profiles.

for **cart 45 / 60**

Load capacity up to 12 kg
cart 45 Ref. no. **25064**
cart 60 Ref. no. **25062**

Load capacity up to 18 kg
cart 45 Ref. no. **25055**
cart 60 Ref. no. **25063**

“alegro”
holder for monitor
on horizontal arm



made of metal, grey-white (RAL 9002).

for **cart 45**

Dim.: 450 x 127 x 522 mm (w x d x h)

Load capacity up to 12 kg
Ref. no. **12251**

for **cart 60**

Dim.: 600 x 127 x 522 mm (w x d x h)

Load capacity up to 12 kg
Ref. no. **12250**

“alegro”
monitor holder
on swivel arm



with 1 hinge joint and integrated cable duct. Reach 300 mm.

Load capacity up to 12 kg
Ref. no. **25024**

Load capacity up to 18 kg
Ref. no. **25050**

“alegro”
monitor holder
on swivel arm



with 2 hinge joints and integrated cable duct. Reach 300 mm.

Load capacity up to 12 kg
Ref. no. **25020**

Load capacity up to 18 kg
Ref. no. **25046**

“alegro”
monitor holder
on articulated arm



with adapter angle outside or inside of the carrier profile and integrated cable duct. Reach 300 mm.

Load capacity up to 12 kg
Ref. no. **25013**

Load capacity up to 18 kg
Ref. no. **25039**

“alegro”
monitor holder
on double
articulated arm



with adapter angle outside or inside of the carrier profile and integrated cable duct. Reach 2 x 150 mm.

Load capacity up to 12 kg
Ref. no. **25014**

Load capacity up to 18 kg
Ref. no. **25040**

Dressing dispenser / Injection sets / KOMBI set

COMPACT dressing dispenser



High quality casing, white plastic veneered, dust-proof sealed by plexi-glass cover. Ideally arranged for easy access. To be fixed between the profiles.

Dim.:
600 x 220 x 450 mm (w x d x h)
Ref. no. 13913

COMPACT injection set



High quality casing, white plastic veneered, dust-proof sealed by plexi-glass cover. Ideally arranged for easy access. To be fixed between the profiles.

Dim.:
600 x 220 x 450 mm (w x d x h)
Ref. no. 13914

PicBox® injection set



The dispenser with the first-in/first-out guarantee in accordance with DIN 58953. Grey-white plastic casing with clear glass boxes. The boxes are replenished from the top, the material taken from below. Each box with a separate covering lid (dust-proof). Consisting of syringe dispenser with 3 boxes and canula dispenser with 5 boxes. To be fixed between the profiles.

Dim.:
600 x 220 x 410 mm (w x d x h)

Ref. no. 13915

KOMBI set



made of grey-white, unbreakable plastic for taking blood samples and giving injections. With TAKEFIX swab dispenser and TIPPFIX swab moisturiser plus additional container.

Recommended as an attachment to the PicBox® injection set.

Dim.:
120 x 225 x 270 mm (w x d x h)
Ref. no. 13916

Various accessories

Stability corners



Set of 4 stability corners, made of black cellular rubber, adhesive on one side. For securing the devices when the cart is moved.

Dim.:
40 x 40 x 5 mm (w x d x h)
Ref. no. 17222

Universal holder snap



for boxes of disposable gloves, tissues or wipes. The spring-loaded clamp is adjustable to fit many box sizes up to 1 kg; for single-handed operation, with mounting for carrier profile.

Ref. no. 15606

Holder for dispenser boxes



made of brushed stainless steel. Suitable for 1 to 4 common dispenser boxes of disposable gloves or tissues, with mounting material for **swingo** or **swingo-clinic**.

Holder 1-fold (for 1 box)
Inner dim.:
142 x 94 x 250 mm (w x d x h)
Ref. no. 13026

Holder 3-fold (for 3 boxes)
Inner dim.:
253 x 94 x 394 mm (w x d x h)
Ref. no. 13027

Holder 4-fold (for 4 boxes)
Inner dim.:
253 x 94 x 525 mm (w x d x h)
Ref. no. 05071

Schluckfix canula container



Disposable container for approx. 500 used canulas, made of black recycled plastic.

Dim.:
55 x 100 x 170 mm (w x d x h)
Schluckfix set
with 20 boxes and attachment
Ref. no. 13917

Schluckfix carton
with 100 boxes without attachment
Ref. no. 09490

Attachment

for Schluckfix, separately.
Ref. no. 13918

Sensor dispenser



made of naturally anodised aluminium, for 1 litre standard bottles with soap or disinfectants. Can be mounted to the left or right side. Please specify when ordering.

Dim.:
95 x 210 x 290 mm (w x d x h)
Ref. no. 16204

Drip tray

separately, removable
Ref. no. 16256

Soap and disinfectant dispenser



Fastening at the right or left side is possible. Made of naturally anodised aluminium. For standard bottles with capacity of 1 litre.

Dim.:
95 x 185 x 290 mm (w x d x h)
Ref. no. 16087

Drip tray

separately, removable
Ref. no. 16256

**Disposal box
"Medi-Müll"
à 1,5 ltr.**



made of yellow polypropylene with green lid. Offers 3 practical ways for the disposal of all types of canulas and vacutainers. Ideally suited for scalpels, pipettes, broken glass, swabs etc.

Height 152 mm
Ø of the lid 143 mm,
Ø of the base 108 mm

Set with **20 boxes** and mounting.

Ref. no. **13919**

Graduated prices on request.

"Medi-Müll"

carton with **100 boxes**, without mounting

Ref. no. **16653**

Mounting

separately for „Medi-Müll“

Ref. no. **13920**

Arm support



black, padded with integral upholstered foam, with 2 attachment hooks, extra sturdy.

Ref. no. **13923**

Catheter holder



made of stainless steel, 3 compartments, for hanging on standard profile rail.

Dim.:
160 x 96 x 570 mm (w x d x h)

Ref. no. **13959**

Please order standard profile rail for lateral mounting, ref. no. 13924.

Holder



for oxygen bottle of 2 ltrs., silver-aluminium.

Upper supporting ring Ø 102 mm, lower supporting ring Ø 84 mm.

Ref. no. **13956**

Infusion bottle holder



chrome plated, with 4 hooks Ø 25 mm, for use with one hand.

Ref. no. **13927**

**"CUPFIX"
ampoule opener**



Plastic casing, grey-white, collecting container for ampoules, removable. Diamond file, spring loaded, mounted in stainless steel plate.

Dim.:
70 x 150 x 200 mm (w x d x h)

Ref. no. **13921**

Replacement diamond file for „CUPFIX“
Ref. no. **04663**

Mounting

separately for „CUPFIX“

Ref. no. **13922**

Reanimation board with holder



made of sturdy blue polyethylene, 2 kg lightweight. Supports up to 150 kg. Holder made of stainless steel. Anatomically shaped head hollow for the correct placement during heart massage. Suitable for trolleys with minimum 380 mm high rear walls.

Dim.:
600 x 420 x 60 mm (w x d x h)

Ref. no. **17370**

Standard profile rail



for lateral mounting with 2 fixing points, made of stainless steel.

Length 420 mm

Ref. no. **13924**

Standard profile rail



for rear mounting with 2 fixing points, made of stainless steel.

Length 440 mm

Ref. no. **13953**

Holder



for oxygen bottle 5/10 Litres. with Ø up to 145 mm; upper holder with fixing tape included.

Ref. no. **16322**

Upper holder with fixing tape, separately

Ref. no. **16324**

Universal endoscope holder



made of plexiglass with several openings for endoscope and accessories. Height-adjustable rod, for single-handed operation.

Ref. no. **13979**

Endoscope tube of plexiglass, open at the bottom, 120 cm long, inside Ø 3,2 cm, outside Ø 4 cm, with holding clips for **swingo®**.

Ref. no. **13977**

As above, closed at the bottom for disinfectant solution.

Ref. no. **13978**

Cable and hose holder



grey, range approx. 950 mm, made of silver coloured aluminium, with one-hand push-button adjustment. 2 joints, 2 cable routing elements. With attachment device.

Ref. no. **13926**

Cable and hose holder with flex-shaft



with 2 joints of plastic, arms in silver aluminium and chromium-plated flex-shaft. With attachment device.

Ref. no. **16651**

Hook



made of white plastic.

Dim.:
34 x 66 x 70 mm (w x d x h)

Ref. no. **15171**

Cable clip



made of grey plastic. For fixing to the profile slot.

Ref. no. **19015**

Holder for Kensington-Lock



Attached to the profile for theft-protection of notebooks. Without lock.

Ref.- Nr. **16424**

Holder for camera



made of plastic (POM = polyoxymethylene).

Dim.:
25 x 6 x 40 mm (w x d x h)

Ref. no. **15390**

Halux® LED F 7-P



LED examination lamp with spring balanced swivel arm. The lamp head has a double-wall casing for optimized cooling.

Light output: **15.000 Lux / 0.5 m**

Supply voltage: 100 - 240 V; 50/60 Hz

Ref. no. **05522**

Clamp for **swingo®**
Ref. no. **14659**

Other LED-lamps on request.

Attachment device



for universal use with all **swingo®** and **swingo®-clinic** attachments. Suitable for use on circular pipes of Ø 10 mm and Ø 16 mm.

Ref. no. **13929**

Multiple socket outlet 4-fold



4 grounding sockets, 3 m long, with moulded grounding plug, green 2-pin switch, quality housing anodised aluminium, 2 grey plastic fastening angles included.

Dim.:
269 x 44 x 44 mm (w x d x h)

Ref. no. **21693**

Further multiple socket outlets you will find in the separate electrical accessories list.

Electrical accessories

Suitable for the equipment cart systems, we offer you a comprehensive range of electrical accessories in various country-specific versions. Please ask us!

- The product range contains:
- Standard multiple socket outlets
 - Modular multiple socket outlets
 - Central on/off switch
 - Isolating transformers
 - Equipotential bonding system MultiContact POAG
 - Electrical connections according to IEC 320 C13/C14
 - Cable management and plug-out protection

All prices are understood exclusive of VAT. As an innovative company we reserve the right to amend prices and designs. As for the rest our General Terms of Business in the valid version apply.

WEEE-Reg. no. DE 20235235



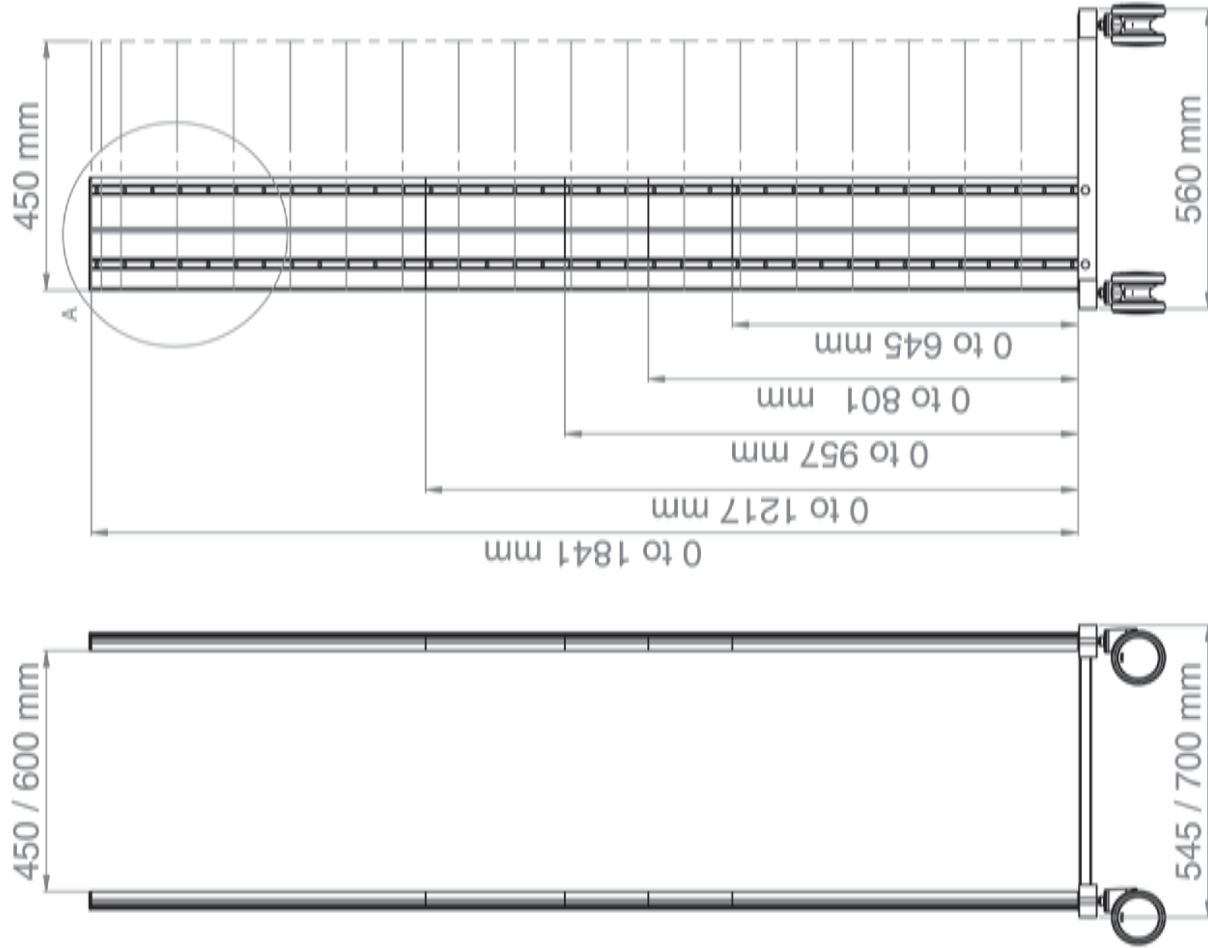

swingo swingo-clinic

wood-plastic



metal



Example: Installation

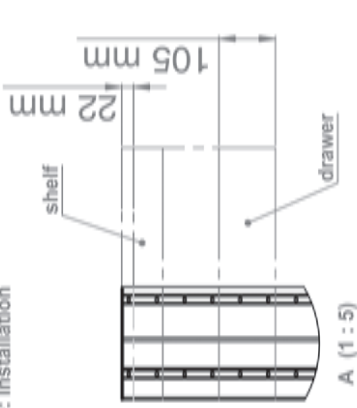

Colour of decorative strips and push handles

grey

blue

yellow



Height of profile

standard

645 mm

801 mm

957 mm

1217 mm

variable

0 - 636 mm

0 - 1217 mm

0 - 1841 mm

(Grids = 52 mm)

For optimal stability, each cart with a profile height up from 957 mm has to be equipped with one horizontal arm, ref. no. 16555 or ref. no. 16554

Chassis / castors / load capacity:



castors Ø100

45

Cart

60

(swingo up to 120 kg)
(swingo-clinic up to 130 kg)

45

with 2
brakes

60



castors Ø125, 2 lockable

45

60

(swingo up to 120 kg)
(swingo-clinic up to 130 kg)

45

with 2
brakes

60



castors Ø150, 2 lockable

45

60

(swingo up to 120 kg)
(swingo-clinic up to 250 kg)

45

with 2
brakes

60



castors Ø100

45

60

with base plate 300 mm deep
(swingo up to 120 kg)
(swingo-clinic up to 130 kg)

45

with 2
brakes

60



castors Ø150, 2 lockable

45

60

extended to the rear,
electrically conductive
(swingo up to 120 kg)
(swingo-clinic up to 250 kg)

45

with 2
brakes

60

4 electrically
conductive
castors

60

HAEBERLE

mobile workstations

Our versatile product range

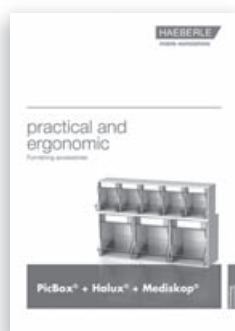

Your medical distributor

HAEBERLE GmbH + Co. KG

Breitwiesenstr. 13, DE-70565 Stuttgart

P.O.Box 800524, DE-70505 Stuttgart

Phone +49 (0) 711/78314-0

Fax +49 (0) 711/78314-77

info@haeberle-med.de

www.haerberle-med.de

Version 07/19