

HAEBERLE

multifunctional cart systems

type list

valid up from 1 July 2012

*With elegant
new lift models*

fuego + fuego-cuatro

Equipment cart system
... flexible and versatile



fuego - the flexible and versatile equipment cart system

by HAEBERLE

Extraordinary design makes the cart system stand out from the crowd and makes it ideal for small device combinations. The fuego carts are versatile, but also robust and offer a large storage space over a small surface area. The svelte lines of the fuego carts mean they can be used in the most diverse fields of application.

Features Different decorative colours available, robust chassis, a single-support aluminium profile for mounting socket boards with integrated cable channel, stable shelves with a moulded edge and a recessed grip, with an ergonomic push handle as standard. Now still more flexibly with elegant new lift version for steplessly adjustable working comfort.

Function: As a mobile equipment card, ECG cart, beauty trolley, laptop or computer cart, a mobile desk, a lift cart with stepless height adjustment for performing activities whilst standing or seated ...and more.

Application: In doctors' practices, clinics, cosmetics studios, offices, conference and meeting rooms.

You may choose your individual cart with the chassis fuego or with the new "four-wheel drive" chassis fuego-cuatro.

Chassis fuego

- elegant
- sturdy, straight castor motion thanks to fixed rear castors
- stable cart steering, also for long distances
- 2 steerable, 2 fixed castors
- front castors dia. 65 mm, rear castors dia. 125 mm
- total loading capacity: 50 kg

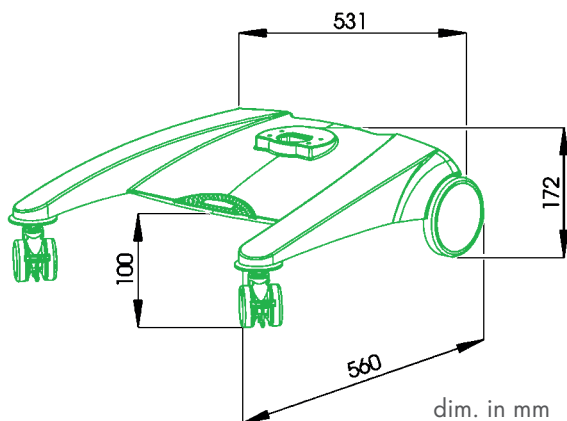

Chassis fuego-cuatro

- dynamic
- smaller turning circle thanks to steerable rear castors
- ideal for applications with small working radius
- 4 steerable castors
- front castors dia. 75 mm, rear castors dia. 100 mm
- total loading capacity: 60 kg

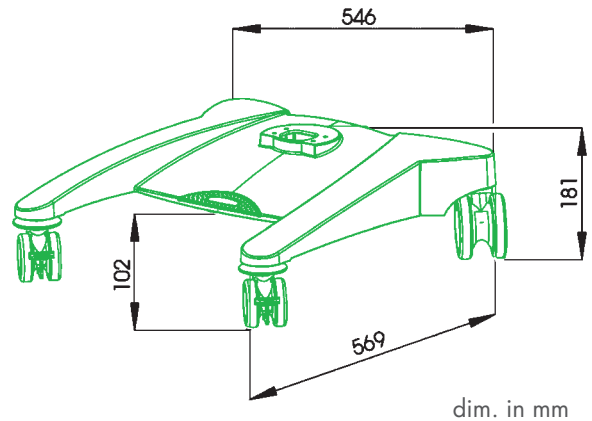

Components:

- Sturdy and very versatile chassis frame with high-grade quality castors
- Stable single-support aluminium profile for multiple socket boards, with large integrated cable channel for optimal accommodation of cables
- High-quality trays with shaped edge and recessed grip
- Beautifully designed drawer
- Elegant, steplessly adjustable and tilted desk shelves with roll protection for use, e.g. as mobile desk for lectures, presentations etc.
- Console shelves for small devices with stepless height adjustment
- Produced as standard with ergonomic handle and additional grey plastic cable storage clip, fixed to the rear of the profile
- Lift carts with stepless height adjustment for sitting or standing work positions
- Accessories for individual fields of applications

Technical details and dimensions:

Complete load limit of the equipment cart:	fuego 50 kg / fuego-cuatro 60 kg
Carrier column height:	800 mm or 950 mm
Front castor diameter:	fuego 65 mm / fuego-cuatro 75 mm
Rear castor diameter:	fuego 125 mm / fuego-cuatro 100 mm
Electrically conductive castors:	available at additional charge
Trays external dimensions:	501 x 386 x 54.8 mm (w x d x h)
Trays footprint dimensions:	approx. 465 x 340 mm (w x d)
Desk shelves external Dimensions:	495 x 542 x 18 mm (w x d x h)
Desk shelves tilt:	20°
Console shelves external Dimensions:	431 x 330 x 15 mm (w x d x h)
Load limit trays/desk shelves/Console shelves:	approx. 15 kg
Drawer external dimensions:	494 x 386 x 131 mm (w x d x h)
Load limit per drawer:	approx. 10 kg

Materials and colours:

Carrier column:	Anodised aluminium
Profile canopy/cover:	Plastic, ABS, grey (6502B in accordance with NCS)
Chassis frame:	Aluminium cast, powder-coated grey (RAL 7012), fine structure
Decorative strips made of polyvinyl chlorid:	grey (6502B in accordance with NCS) blue (3050-R80B in accordance with NCS) red-violet (3050-R40B in accordance with NCS) yellow (0050-Y in accordance with NCS) turquoise (1050-B50G in accordance with NCS)
Handle / rail:	Steel tube, high-grade powder-coated RAL 9006 (white aluminium)
Trays:	high-grade and easy-care plastic, ABS, grey alternatively steel, powder-coated, RAL 9006
Desk shelves / console shelves:	multiplex, stable hard-wearing laminate wood, birch, grey stain,
Drawer:	ABS oriongrey with polished surface
Castors	Polyurethan

Item	Description	Ref. no.
------	-------------	----------

Equipment carts

All carts can be delivered with the chassis fuego or the chassis fuego-cuatro. For a low surcharge the fuego-carts mentioned can be ordered with the chassis fuego-cuatro, ref. no. 19538. The carts are delivered ready assembled.

basic cart

fuego 1



with 1 drawer, 1 push handle and 1 clip-holder for cable.

Dim.: 531 x 560 x 977 mm (w x d x h)

Colour of decorative strips:

grey	1906.1
blue	1906.2
red violet	1906.3
yellow	1906.4
turquoise	1906.5

fuego 1 with drawer



with 1 drawer, 1 tray, 1 push handle and 1 clip-holder for cable.

Dim.: 531 x 560 x 977 mm (w x d x h)

Colour of decorative strips:

grey	1937.1
blue	1937.2
red violet	1937.3
yellow	1937.4
turquoise	1937.5

fuego 1 with basket



with 1 drawer, 1 tray, 1 wire basket, forwards extensible (steel, powder-coated, RAL 9006), 1 push handle and 1 clip-holder for cable.

Dim.: 531 x 560 x 977 mm (w x d x h)

Colour of decorative strips:

grey	1969.1
blue	1969.2
red violet	1969.3
yellow	1969.4
turquoise	1969.5

fuego 2



with 2 trays, 1 push handle and 1 clip-holder for cable.

Dim.: 531 x 560 x 977 mm (w x d x h)

Colour of decorative strips:

grey	1907.1
blue	1907.2
red violet	1907.3
yellow	1907.4
turquoise	1907.5

fuego 9







with 3 trays, 1 push handle and 1 clip-holder for cable.

Dim.: 531 x 560 x 1127 mm (w x d x h)

Colour of decorative strips:

grey	1957.1
blue	1957.2
red violet	1957.3
yellow	1957.4
turquoise	1957.5

Item	Description	Ref. no.										
computer trolleys / lift carts with height adjustment												
fuego-cuatro computer trolley 2		<p>with 1 tray and push handle, TFT screen mount, with a keyboard branch provided with a mouse pull-out; both attached to a height-adjustable column, multiple socket outlet with 4 sockets, PC support (right side), 1 clip-holder for cable.</p> <p>Dim.: 546 x 569 x 1440 mm (w x d x h)</p> <p>Colour of decorative strips:</p> <table border="0"> <tr><td>grey</td><td style="text-align: right;">1958.1</td></tr> <tr><td>blue</td><td style="text-align: right;">1958.2</td></tr> <tr><td>red violet</td><td style="text-align: right;">1958.3</td></tr> <tr><td>yellow</td><td style="text-align: right;">1958.4</td></tr> <tr><td>turquoise</td><td style="text-align: right;">1958.5</td></tr> </table> <p>PC support for fastening on the left side of the column on request.</p>	grey	1958.1	blue	1958.2	red violet	1958.3	yellow	1958.4	turquoise	1958.5
grey	1958.1											
blue	1958.2											
red violet	1958.3											
yellow	1958.4											
turquoise	1958.5											
fuego-cuatro computer trolley 3		<p>with 1 tray and push handle, TFT screen mount, attached to a height-adjustable column, with a pull-out keyboard shelf and mouse pull-out, multiple socket outlet with 4 sockets, PC support (right side), 1 clip-holder for cable.</p> <p>Dim.: 546 x 569 x 1352 mm (w x d x h)</p> <p>Colour of decorative strips:</p> <table border="0"> <tr><td>grey</td><td style="text-align: right;">1959.1</td></tr> <tr><td>blue</td><td style="text-align: right;">1959.2</td></tr> <tr><td>red violet</td><td style="text-align: right;">1959.3</td></tr> <tr><td>yellow</td><td style="text-align: right;">1959.4</td></tr> <tr><td>turquoise</td><td style="text-align: right;">1959.5</td></tr> </table> <p>PC support for fastening on the left side of the column on request.</p>	grey	1959.1	blue	1959.2	red violet	1959.3	yellow	1959.4	turquoise	1959.5
grey	1959.1											
blue	1959.2											
red violet	1959.3											
yellow	1959.4											
turquoise	1959.5											
fuego-cuatro with lift for laptop <i>new elegant lift version</i>		<p>The cart is suitable for sitting and standing activities. 1 tray with front handle, integrated tripping lever for a steplessly variable height adjustment (70 - 100 cm). Inclusive push handle and clip-holder for cable. The base version of the comfortable lifting unit has a load capacity up to 7 kg.</p> <p>Dim.: 546 x 569 x 960 mm (w x d x h)</p> <p>Colour of decorative strips:</p> <table border="0"> <tr><td>grey</td><td style="text-align: right;">1978.1</td></tr> <tr><td>blue</td><td style="text-align: right;">1978.2</td></tr> <tr><td>red violet</td><td style="text-align: right;">1978.3</td></tr> <tr><td>yellow</td><td style="text-align: right;">1978.4</td></tr> <tr><td>turquoise</td><td style="text-align: right;">1978.5</td></tr> </table>	grey	1978.1	blue	1978.2	red violet	1978.3	yellow	1978.4	turquoise	1978.5
grey	1978.1											
blue	1978.2											
red violet	1978.3											
yellow	1978.4											
turquoise	1978.5											
fuego-cuatro PC-trolley with lift <i>new elegant lift version</i>		<p>The cart is suitable for sitting and standing activities. 1 keyboard and mouse pull-out shelf with mouse holder sideways (on right or left side), front handle, integrated tripping lever for a steplessly variable height adjustment (70 - 10 cm). Inclusive alegre monitor holder, PC support (on right side), multiple socket outlet (4-fold), push handle and clip-holder for cable. The base version of the comfortable lifting unit has a load capacity up to 7 kg.</p> <p>Dim.: 546 x 569 x 960 mm (w x d x h)</p> <p>Colour of decorative strips:</p> <table border="0"> <tr><td>grey</td><td style="text-align: right;">1979.1</td></tr> <tr><td>blue</td><td style="text-align: right;">1979.2</td></tr> <tr><td>red violet</td><td style="text-align: right;">1979.3</td></tr> <tr><td>yellow</td><td style="text-align: right;">1979.4</td></tr> <tr><td>turquoise</td><td style="text-align: right;">1979.5</td></tr> </table> <p>Surcharge for lifting unit up to 11 kg load capacity 19756</p> <p>Surcharge for lifting unit up to 15 kg load capacity 19757</p> <p>PC support on the left side of the profile on request.</p>	grey	1979.1	blue	1979.2	red violet	1979.3	yellow	1979.4	turquoise	1979.5
grey	1979.1											
blue	1979.2											
red violet	1979.3											
yellow	1979.4											
turquoise	1979.5											

Item	Description	Ref. no.										
fuego cart for notebook		<p>with plate for notebook and mouse pad, extensible to the right or left side, RAL 9006 white aluminium powder coated steel. Wire basket to be mounted at the rear side of the column. Multiple socket outlet with 4 sockets, push handle and 1 clip-holder for cable.</p> <p>Dim.: 531 x 560 x 1127 mm (w x d x h)</p> <p>Colour of decorative strips:</p> <table> <tr><td>grey</td><td>1952.1</td></tr> <tr><td>blue</td><td>1952.2</td></tr> <tr><td>red violet</td><td>1952.3</td></tr> <tr><td>yellow</td><td>1952.4</td></tr> <tr><td>turquoise</td><td>1952.5</td></tr> </table>	grey	1952.1	blue	1952.2	red violet	1952.3	yellow	1952.4	turquoise	1952.5
grey	1952.1											
blue	1952.2											
red violet	1952.3											
yellow	1952.4											
turquoise	1952.5											

ergometry carts / ECG carts

fuego-cuatro ergometry cart 1		<p>with 2 trays, 1 wire basket, cable and hose holder, ref. no. 19034, push handle and 1 clip-holder for cable.</p> <p>Dim.: 546 x 569 x 1136 mm (w x d x h)</p> <p>Colour of decorative strips:</p> <table> <tr><td>grey</td><td>1962.1</td></tr> <tr><td>blue</td><td>1962.2</td></tr> <tr><td>red violet</td><td>1962.3</td></tr> <tr><td>yellow</td><td>1962.4</td></tr> <tr><td>turquoise</td><td>1962.5</td></tr> </table>	grey	1962.1	blue	1962.2	red violet	1962.3	yellow	1962.4	turquoise	1962.5
grey	1962.1											
blue	1962.2											
red violet	1962.3											
yellow	1962.4											
turquoise	1962.5											

fuego ergometry cart 2		<p>with 2 trays, 1 drawer, 1 steel-plate, powder-coated RAL 9006 (ref. no. 19330), 1 bracket plate made of steel, powder-coated RAL 9006 (ref. no. 19546) with upturn beams (height adjustable and rotatable), dim. of the bracket plate: 370/300 x 272 mm (w1/w2 x d), 1 cable and hose holder (ref. no. 19034), 1 clip-holder for cable and push handle.</p> <p>Dim.: 531 x 560 x 1126 mm (w x d x h) (without bracket plate and cable and hose holder)</p> <p>Colour of decorative strips:</p> <table> <tr><td>grey</td><td>1968.1</td></tr> <tr><td>blue</td><td>1968.2</td></tr> <tr><td>red violet</td><td>1968.3</td></tr> <tr><td>yellow</td><td>1968.4</td></tr> <tr><td>turquoise</td><td>1968.5</td></tr> </table>	grey	1968.1	blue	1968.2	red violet	1968.3	yellow	1968.4	turquoise	1968.5
grey	1968.1											
blue	1968.2											
red violet	1968.3											
yellow	1968.4											
turquoise	1968.5											

fuego-cuatro ECG cart 1 prepared for taking up the suction unit Strässle DT 100		<p>with 2 trays, push handle and 1 clip-holder for cable.</p> <p>The cart is prepared to take up the suction unit, but delivery is WITHOUT suction unit.</p> <p>Dim.: 546 x 569 x 1050 mm (w x d x h)</p> <p>Colour of decorative strips:</p> <table> <tr><td>grey</td><td>1960.1</td></tr> <tr><td>blue</td><td>1960.2</td></tr> <tr><td>red violet</td><td>1960.3</td></tr> <tr><td>yellow</td><td>1960.4</td></tr> <tr><td>turquoise</td><td>1960.5</td></tr> </table>	grey	1960.1	blue	1960.2	red violet	1960.3	yellow	1960.4	turquoise	1960.5
grey	1960.1											
blue	1960.2											
red violet	1960.3											
yellow	1960.4											
turquoise	1960.5											

Item	Description	Ref. no.
------	-------------	----------

**fuego-cuatro
ECG cart 2
prepared for taking
up the suction unit
KISS**



with 2 trays, push handle and 1 clip-holder for cable.

The cart is prepared to take up the suction unit, but delivery is WITHOUT suction unit.

The supporting tube of the KISS suction unit has to be adapted at our factory. Please send us the supporting tube of the suction unit together with your order.

Dim.: 546 x 569 x 989 mm (w x d x h)

Colour of decorative strips:

grey	1961.1
blue	1961.2
red violet	1961.3
yellow	1961.4
turquoise	1961.5

sonography cart / endoscopy cart / infusion cart

**fuego
sonography cart**

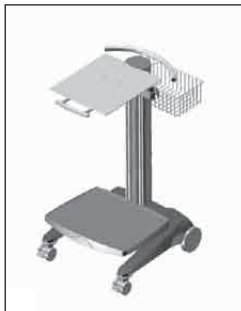

with 1 tray, 1 steel-plate with handle (ref. no. 19539), white powder-coated aluminium RAL 9006, dim. 350 x 400 x 4 mm (w x d x h), 1 wire basket at the rear, attachment for ultrasonic probe, inner dia. 43 mm, 1 clip-holder for cable and push handle.

Dim.: 531 x 746 x 977 mm (w x d x h)

Colour of decorative strips:

grey	1970.1
blue	1970.2
red violet	1970.3
yellow	1970.4
turquoise	1970.5

**fuego
endoscopy cart**



with 3 trays, multiple socket outlet with 4 sockets, universal holder for endoscopy on height-adjustable rod (adjustment height up to ca. 800 mm), for one-hand use, 1 clip-holder for cable and push handle.

Dim.: 531 x 560 x 1347 mm (w x d x h)

Colour of decorative strips:

grey	1916.1
blue	1916.2
red violet	1916.3
yellow	1916.4
turquoise	1916.5

**fuego
infusion cart**



with tray and drawer, infusion bottle holder, infusion pump holder (ref. no. 19547) dim. 470 x 600 mm (w x h), multiple socket outlet with 4 sockets, 1 clip-holder for cable and push handle.

Dim.: 531 x 560 x 977 mm (w x d x h)

Colour of decorative strips:

grey	1967.1
blue	1967.2
red violet	1967.3
yellow	1967.4
turquoise	1967.5

System parts

The reference numbers of the system parts include the complete range of attachment fittings.

chassis / castors / tray / distance piece / front handle / rail

chassis fuego



with carrier column, push handle, clip-holder for cable, **2 fixed castors at rear, dia. 125 mm and 2 steerable castors in front, dia. 65 mm.**

Total loading capacity: 50 kg

Carrier column 800 mm high

Dim.:
531 x 560 x 977 mm (w x d x h)

decorative strips: Ref. no.
grey **1926.1**
blue **1926.2**
red violet **1926.3**
yellow **1926.4**
turquoise **1926.5**

Carrier column 950 mm high

Dim.:
531 x 560 x 1127 mm (w x d x h)

decorative strips: Ref. no.
grey **1927.1**
blue **1927.2**
red violet **1927.3**
yellow **1927.4**
turquoise **1927.5**

chassis fuego-cuatro



with carrier column, push handle, clip-holder for cable, **4 steerable castors, at rear dia. 100 mm, in front, dia. 75 mm.**

Total loading capacity: 60 kg

Carrier column 800 mm high

Dim.:
546 x 569 x 986 mm (w x d x h)

decorative strips: Ref. no.
grey **1965.1**
blue **1965.2**
red violet **1965.3**
yellow **1965.4**
turquoise **1965.5**

Carrier column 950 mm high

Dim.:
546 x 569 x 1136 mm (w x d x h)

decorative strips: Ref. no.
grey **1966.1**
blue **1966.2**
red violet **1966.3**
yellow **1966.4**
turquoise **1966.5**

castors fuego



for 4 electrically conductive castors, 2 castors in front Ø 65 mm (lockable) 2 castors at rear Ø 125 mm (fixed)

Ref. no. **19023**

castors fuego-cuatro



for 4 electrically conductive castors, 2 castors in front Ø 75 mm (lockable) 2 castors at rear Ø 100 mm (steerable)

Ref. no. **19481**

tray



ABS plastic

Storage space dim:
464 x 340 mm (w x d),

Exterior dim.:
501 x 386 x 54,8 mm (w x d x h)

Load capacity up to 15 kg. Ref. no. **19033**
Load capacity up to 25 kg. Ref. no. **19237**

distance piece



fitting piece between shelf and column for more depth (3,8 cm)

Ref. no. **19312**

front handle



to be mounted at the front side of a tray, white-aluminium, RAL 9006

Ref. no. **19367**

rail for storage shelf



made from steel tube, high-grade powder-coated RAL 9006 (white aluminium), dia. 8 mm, surrounds shelf on three sides, as additional stop for equipment, fixed at carrier column.

Ref. no. **19017**

shelves / steel-plates / laptop-safe / drawer / drawer inset / keyboard trays / TFT mount



from stable hard-wearing laminate wood, birch, grey stain, with roll protection, fixed tilt 20°, load capacity approx. 15 kg, mechanical height adjustment up to 300 mm.

Dim.:
495 x 542 x 18 mm (w x d x h)
Ref. no. **19087**



medium-density fibreboard (MDF) with particularly fine surface, painted grey, load capacity approx. 15 kg, mechanical height adjustment, adjustment height up to 300 mm.

Dim.:
431 x 330 x 15 mm (w x d x h)
Ref. no. **19088**

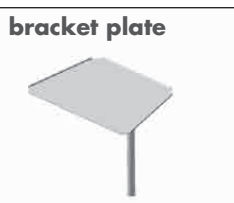

made of steel, powder-coated RAL 9006 with upturn beams, attached on height-adjustable and rotatable rod.

Dim.:
370/300 x 272 mm (w1/w2 x d)
Ref. no. **19546**



powder-coated, RAL 9006. Load capacity up to 25 kg.

Sondermaße auf Anfrage

Dim.:
495 x 379 x 4 mm (w x d x h)
Ref. no. **19330**



with mousepad, extensible to the right or left side; RAL 9006 white aluminium powder coated steel

Setting dim. plate:
491 x 370 mm (w x d)
Mouse pull-out each:
100 x 171 mm (w x d)
Ref. no. **19320**



powder-coated, RAL 9006.

Dim.:
350 x 400 x 4 mm (w x d x h)
Ref. no. **19539**



protects the laptop (up to 17 inches) against theft. Material combination made of grey synthetic material and steel, powder-coated white-aluminium (RAL 9006), mountable on smooth surfaces.

Dim.:
498 (451) x 374 x 84 mm (w x d x h)
without mousepad
Ref. no. **19596**
with mousepad
Ref. no. **19730**



with variable partitions and flexible dividers. Made of transparent synthetic material, removable and suitable for cleaning in the dishwasher.

Ref. no. **19597**

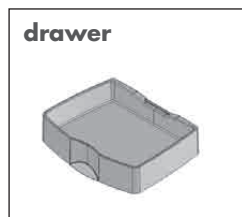

ABS oriongrey with polished surface to be mounted under a tray or under a drawer. Load capacity up to 10 kg.

Dim.:
494 x 386 x 131 mm (w x d x h)
Ref. no. **19300**



keyboard pull-out shelf extendable frontwards by 215 mm; mouse pull-out extendable sideways by 100 mm at each side; RAL 9006 white aluminium powder coated steel.

Ref. no. **19220**
Mouseholder
(on left or right side)
Ref. no. **19488**

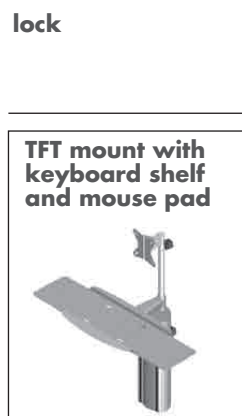

lock for the fuego drawer, separately

Ref. no. **19376**

mount for TFT monitor (VESA 75/100) on height-adjustable rod. Made of chromium steel, max. adjustable height 300 mm, and solid keyboard arm with mouse pullout.

Ref. no. **19222**

TFT holder

TFT mount fixed



mount for TFT monitor, rotatable and inclinable but not height-adjustable. RAL 9006 white aluminium, powder-coated steel.
Load capacity up to 15 kg.

Ref. no. **19418**

TFT mount adjustable



mount for TFT monitor at a height-adjustable rod; RAL 9006 white aluminium powder-coated steel. Load capacity up to 15 kg.

Ref. no. **19223**

alegro - monitor carrier system

For steplessly and precisely fixation without any physical exertion. Horizontally and vertically rotatable, tilting and swivelling function. Monitor adaption VESA 75/100.

alegro monitor holder



on tightly adjusted column in the carrier profile

Load capacity up to 12 kg
Ref. no. **25007**

Load capacity up to 18 kg
Ref. no. **25033**

alegro monitor holder



with fixing bracket for stepless mounting at profile.

Load capacity up to 12 kg
Ref. no. **25052**

Load capacity up to 18 kg
Ref. no. **25053**

alegro holder for double monitoring



on aluminium-traverse (w 600 mm). Steplessly exact fixation without any physical exertion.

Load capacity up to 2 x 12 kg
Ref. no. **25002**

Load capacity up to 2 x 18 kg
Ref. no. **25028**

Accessories

All accessories can be easily fitted to the carts. The reference numbers contain the accessory part complete with attachment fittings.

PC support



for fastening sideways to the fuego column; RAL 9006 white aluminium powder coated steel. The flexible fixing strap ensures a firm hold of the processor. It is suitable for all conventional models, as the top mount is vertically adjustable.

right
Ref. no. **19230**

left
Ref. no. **19245**

Cable and hose holder



with 2 joints of plastic, arms in silver aluminium and chromium-plated flex-shaft. With attachment

reach approx. 950 mm

Ref. no. **19034**

Cable and hose holder with flex-shaft



with 2 joints of plastic, arms in silver aluminium and chromium-plated flex-shaft. With attachment

Ref. no. **19396**

Infusion bottle holder



chrome plated with 4 hooks, Ø 25 mm, for one-hand use

Ref. no. **19035**



to be mounted at the front side of the column, steel, powder-coated RAL 9006 (white aluminium)

Dim.:
416 x 267 x 100 mm (w x d x h)

Ref. no. **19135**

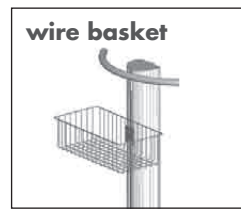

to be mounted at the rear side of the column, steel, powder-coated RAL 9006 (white aluminium)

Dim.:
377 x 196 x 115 mm (w x d x h)

Ref. no. **19146**



wire basket extensible

forwards extensible (215 mm), powder-coated RAL 9006 (white aluminium)

Dim.:
418 x 268 x 100 mm (w x d x h)

Ref. no. **19268**

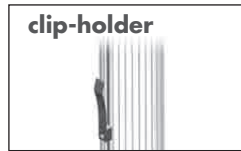

clip-holder

for mains cable, made of plastic, grey

Ref. no. **19015**

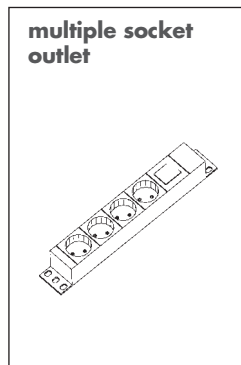

multiple socket outlet

4 grounding sockets, light-grey cable, 3 m long with moulded grounding plug, green 2-pin switch, quality housing anodised aluminium, 2 grey plastic fastening angles included.

Dim.:
269 x 44 x 44 mm (w x d x h)

Ref. no. **21696**

Further multiple socket outlets you will find in the separate electrical accessories list.



holder for Kensington-lock

attached to the profile, for protection of notebooks. Without the lock.

Ref. no. **16424**

electrical accessories

Suitable for the equipment cart systems, we offer you a comprehensive range of electrical accessories in various country-specific versions.

- The product range contains:
- Standard multiple socket outlets
 - Modular multiple socket outlets
 - Central on/off switch
 - Isolating transformers
 - Equipotential bonding system MultiContact POAG
 - Electrical connections according to IEC 320 C13/C14
 - Cable management and plug-out protection

On request we send you the separate list with information about the electrical accessories. Please feel free to contact our customer consultants.

Planning sketches

fuego

Carrier column 800 mm high

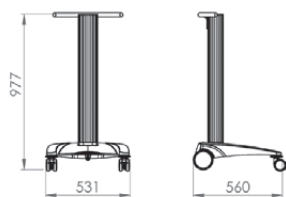

fuego-cuatro

Carrier column 800 mm high

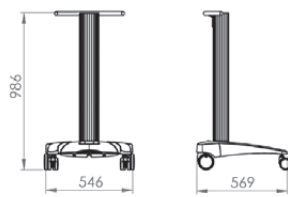

fuego

Carrier column 950 mm high

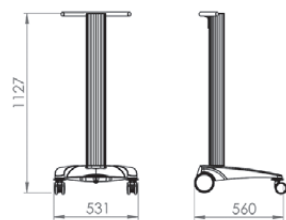

fuego-cuatro

Carrier column 950 mm high

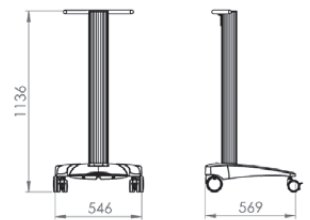

All prices are understood exclusive of VAT. As an innovative company we reserve the right to amend prices and designs. As for the rest our General Terms of Business in the valid version apply.

WEEE-Reg.-Nr. DE 20235235



HAEBERLE specializes in particular in providing customized OEM versions for industrial clients. Let us know your specifications and we will provide you a product according to your individual requirements.



Please contact us!



You may choose your cart with the chassis **fuego** or **fuego-cuatro**.

Our versatile product range

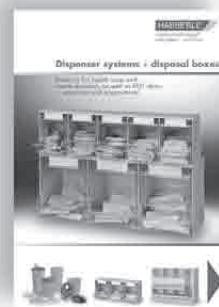

Your medical distributor

HAEBERLE GmbH + Co. KG

Breitwiesenstr. 13

DE-70565 Stuttgart

P.O.Box 800524 · DE-70505 Stuttgart

Phone +49 (0) 7 11/7 83 14-0

Fax +49 (0) 7 11/7 83 14-77

Email: info@haeberle-med.de

Internet: www.haerberle-med.de