



Surgimed Solutions, LLC
INSPIRED CART DESIGNS



Introduction

Since 1997, Surgimed Solutions, LLC has been dedicated to providing the medical OEM marketplace with advanced equipment carts for all healthcare settings. Our advanced mobility and mounting solutions meet the highest industry standards. Superior quality, ergonomic functionality, and aesthetically pleasing designs are the hallmarks of every product that we produce.

Surgimed Solutions offers expert advice as well as professional customer service in keeping with our commitment to provide a positive experience to all of our customers.

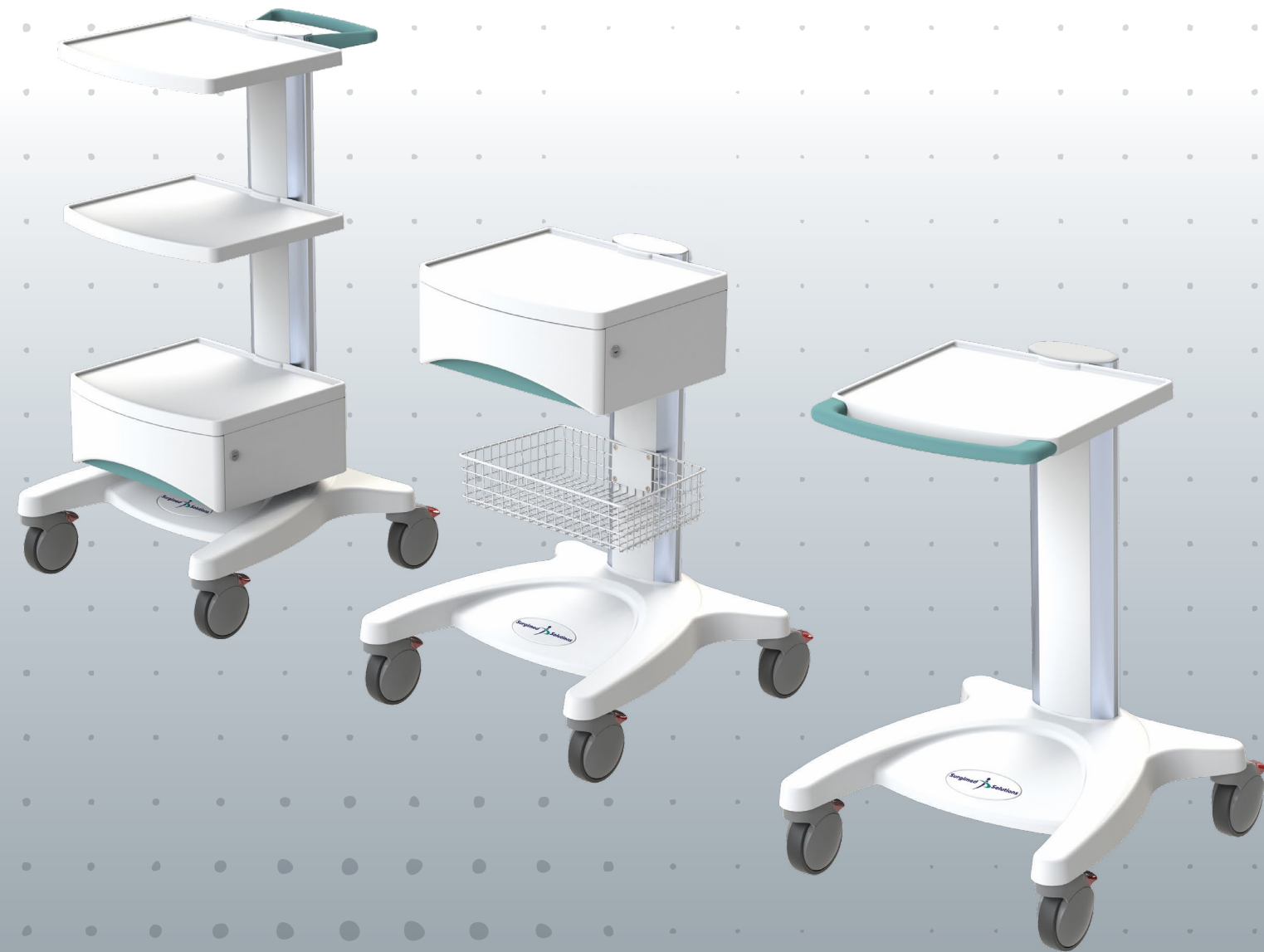

EquiSys

Elegance In Modular Cart Design

The EquiSys modular concept means that dozens of cart configurations are possible from a few basic components and accessories!

The heart of our system is the chassis which consists of a lightweight cast aluminum base on (4) 125mm diameter casters. When coupled with our sturdy extruded aluminum column, the result is a solid foundation onto which the rest of the cart can be built.

Our shelves are also made of cast aluminum which are extremely strong and lightweight. All components and accessories are designed with smooth surfaces, rounded corners, and enclosed seams to ensure safe utility as well as easy cleaning.



Modularity
Infinite configurations are possible, limited only by your imagination.

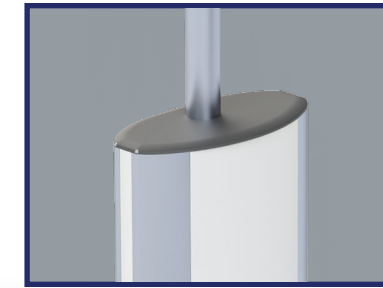

Disinfection
Smooth, easy to clean surfaces with minimal seams and openings.



Branding
Various labeling options are available including color coordinated accents.

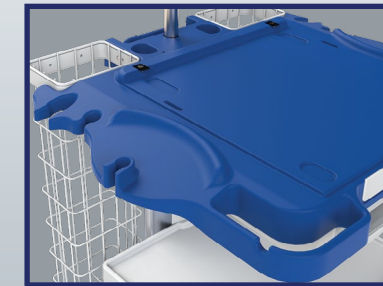

Hybrid
Hybrid utilizes our standard chassis and strategically customized components resulting in a cart that is uniquely yours.



ISO 13485:2016
Our Quality Management System conforms to ISO 13485:2016.

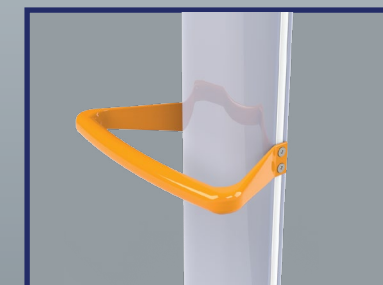

Aesthetics
Visually pleasing lines combined with robust construction culminates in a product that is of the highest quality.

EquiSys Design Details



Chassis

The foundation of every cart. Sturdy, robust, yet elegant. Includes casters, aluminum base, and column.

Shelves

Our shelves are cast aluminum featuring smooth surfaces, raised edges, and rounded corners.

Drawers

All drawers can stack and feature silent close glides. An optional lock is available.

Handles

Substantial handles are available for both front and back providing total control of the cart during transport and positioning.

Baskets

Storage baskets can be mounted anywhere on the cart and custom designs are possible.

Monitor Mounts

Whether you want brackets or arms, our fully integrated monitor mounting solutions can meet your every need.

Additional Accessories

A comprehensive line of accessories is available and we specialize in customization.

Branding

Numerous branding options including labeling and color accent coordination exist.

EquiSys Configurations

Infinite configurations are possible through the strategic mounting of shelves, drawers, monitor mounts, and arms. Add any of our standard or customized accessories and you're ready to go!

Available in fixed height or height adjustable versions, EquiSys can meet a myriad of applications including endoscopic video systems, R/F generators, ventilators, ECG systems, and mobile computing.



ES Configuration I

1 ea. Chassis 650
(H = 873mm)
1 ea. Shelf
1 ea. Rear handle



ES Configuration II

1 ea. Chassis 650
(H = 873mm)
1 ea. Drawer
(includes shelf top)
1 ea. Rear handle



ES Configuration III

1 ea. Chassis 900
(H = 1123mm)
1 ea. Shelf
1 ea. Drawer
(includes shelf top)
1 ea. Rear handle
1 ea. IV pole



ES Configuration IV

1 ea. Chassis 900
(H = 1123mm)
1 ea. Shelf
1 ea. Keyboard tray, compact
1 ea. Rear handle
1 ea. VESA mount, tilt/swivel



ES Configuration V

1 ea. Chassis 900
(H = 1123mm)
1 ea. Shelf
with front handle
1 ea. FISSO articulated
ventilator arm



ES Configuration VI

1 ea. Chassis 1320
(H = 1543mm)
1 ea. Shelf
with rear handle
1 ea. Shelf
1 ea. Drawer
(includes shelf top)
1 ea. Height adjustable
monitor arm

PLEASE NOTE!! The configurations shown are representative of *possible* configurations. Please contact us for details on configuring a cart to meet your specific needs.

EquiSys Hybrid

While our EquiSys line is capable of meeting the needs of many applications, we are pleased to offer an enhanced service which we call EquiSys Hybrid.

With Hybrid we use our basic chassis components and offer custom top and accessory solutions based upon the specific customer requirements. This saves in development time, cost, and engineering while still providing a cart solution that is truly customized. We will work closely with your marketing, clinical, and engineering staff to ensure your total satisfaction in form, functionality, and budget.



Standard Chassis - 650

Custom work: Cast aluminum top with integrated 360 degree handles, designed to cradle the device with debossments to match the device feet. Hard fastening bracket to secure device to top.

EquiSys Hybrid (cont'd)

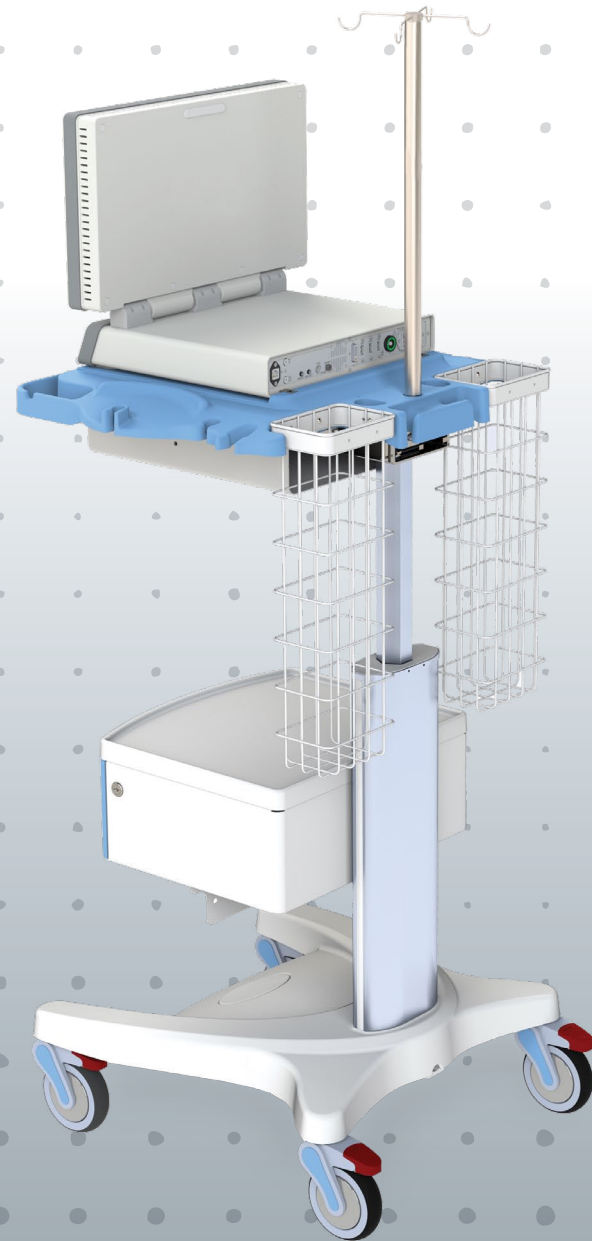
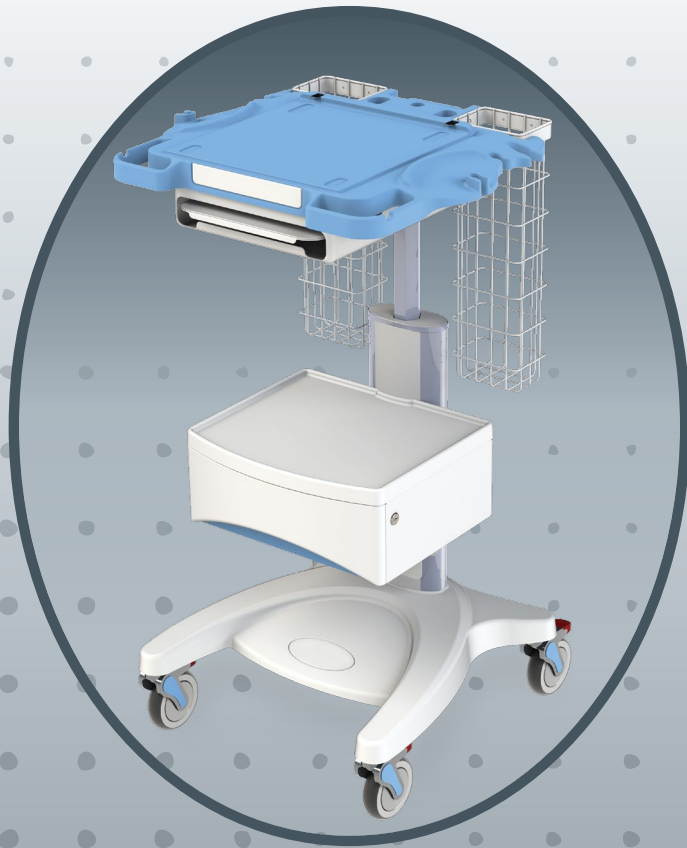

Standard Chassis - 900

Custom work: Custom shelf with reinforced brace to support device weight of 55 lbs. Dual gas bottle holders. Custom regulator bracket. Redesigned handle to accommodate regulator. Custom baskets.

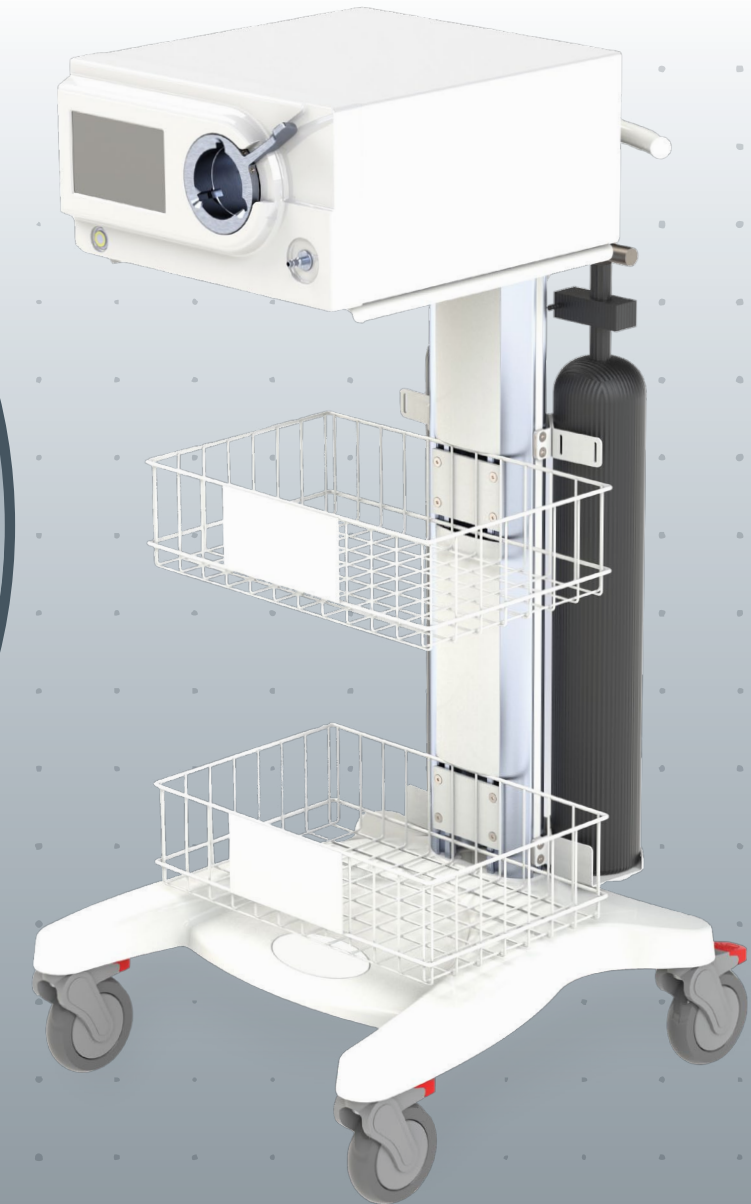

Standard Chassis - 650 with Height Adjustment

Custom work: Highly customized, high density foam top with multiple fittings to hold numerous customer devices, debossments for device feet, and integrated locking tabs. Paddle-type hand actuator for height adjustment. Custom baskets. IV Pole integrated onto height adjustable top.

Notes:

*To learn more about EquiSys
and Surgimed Solutions
please scan QR code:*



*Or visit us at:
www.surgimed-cart.com*

ISO Certification





Surgimed Solutions, LLC

INSPIRED CART DESIGNS

115 Hurley Road – Unit 8D
Oxford, CT 06478

Tel: 860-274-5900 • Fax: 860-274-5906

www.surgimed-cart.com • info@surgimed-cart.com